

# Y

**Y-Series**



# Contents



<b>The d&amp;b System reality</b> .....	4
<b>The Y-Series</b> .....	6
<b>The Y7P loudspeaker and Yi7P loudspeaker</b> .....	10
<b>The Y10P loudspeaker and Yi10P loudspeaker</b> .....	11
<b>The B6 subwoofer and Bi6 subwoofer</b> .....	12
<b>The Y7P, Y10P and B6 transport accessories</b> .....	13
<b>The Y8 loudspeaker and Yi8 loudspeaker</b> .....	14
<b>The Y12 loudspeaker and Yi12 loudspeaker</b> .....	15
<b>The Y subwoofer and Yi subwoofer</b> .....	16
<b>The Y8, Y12 and Y-SUB transport accessories</b> .....	17
<b>The Y-Series mounting accessories and examples</b> .....	18
<b>The Y-Series rigging accessories and examples</b> .....	22
<b>The Yi Weather Resistant and Special Colour options</b> .....	25
<b>The d&amp;b ArrayCalc simulation software</b> .....	26
<b>The d&amp;b NoizCalc immission modelling software</b> .....	28
<b>The d&amp;b R1 Remote control software</b> .....	29
<b>The d&amp;b amplifiers</b> .....	30
<b>The operation with d&amp;b amplifiers</b> .....	32
<b>The Y-Series frequency responses</b> .....	33
<b>The d&amp;b amplifier output modes</b> .....	34
<b>The DS10 Audio network bridge</b> .....	36
<b>The DS100 Signal Engine</b> .....	36
<b>The Y-Series configuration examples</b> .....	37
<b>The Y-Series cables and adapters</b> .....	42
<b>The Y-Series product overview</b> .....	46

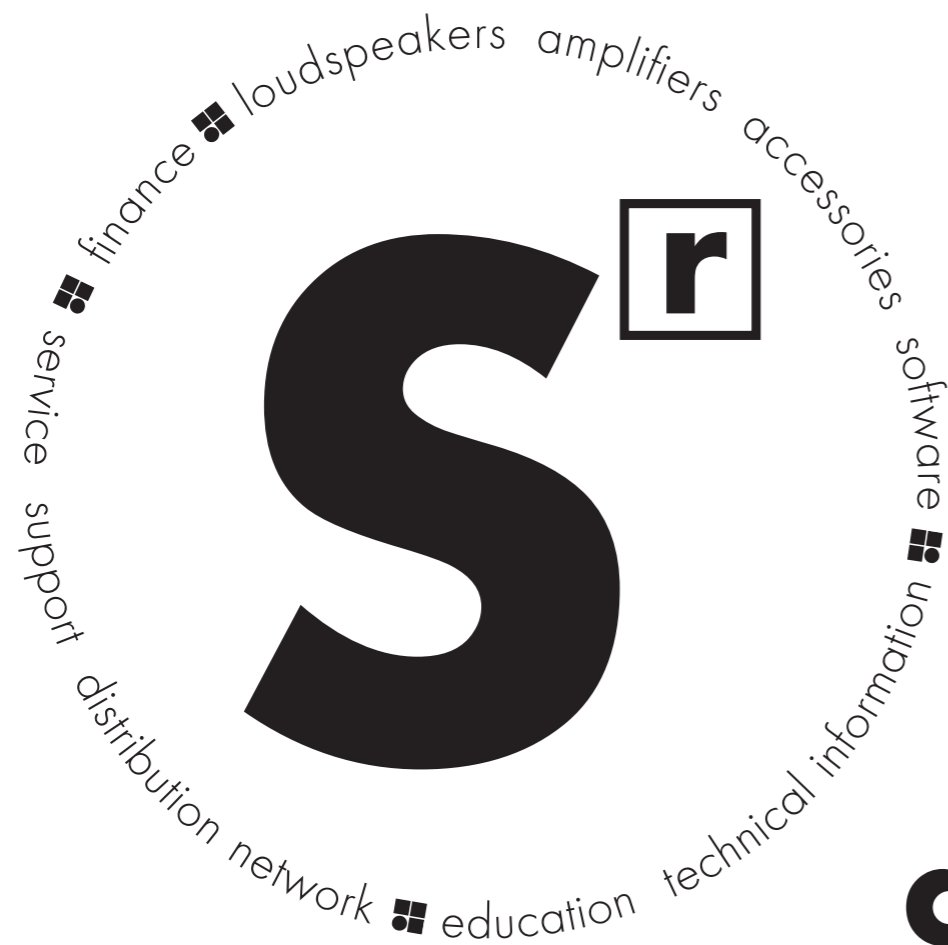

# d&b System reality

As the name implies a d&b audiotechnik system is not just a loudspeaker. Nor is it merely a sum of the components: loudspeakers, amplifiers, signal processors, networking, software and accessories. Right from the outset the d&b audiotechnik approach was to build integrated sound reinforcement systems

that actually are more than the combination of parts: an entirety where each fits all. Every element is tightly specified, precisely aligned and carefully matched to achieve maximum efficiency. For ease of use, all the user-definable parameters are incorporated, allowing the possibility of adjustment, either

directly, via remote control surfaces, or integrated within wider networks. Neutral sound characteristics leave the user all the freedom needed to realize whatever the brief. At the same time d&b offers finance, service and support, a knowledgeable distribution network, education and training as well as technical

information, so the same optimal acoustic result is achieved consistently by every system anywhere, at any time. In reality: the d&b System reality.



The **Y-Series** loudspeakers are designed with a clear perspective to provide flexible and configurable solutions, even in the most arduous sound reinforcement situations. Performing arts, conferences, religious events and live shows; applications all demanding strict qualities in the performance, look and feel of a loudspeaker. On one side the Y-Series provides adept small to

medium scale, stand alone or distributed point source solutions, whereas on the other hand the wide spectrum of mid-sized line array potential is inherited from its bigger brothers, the V-Series and J-Series. Flexible horizontal dispersion characteristics combined with either rotatable horns or innovative custom waveguides ensure constant directivity over a wide bandwidth.

Dipolar driver arrangements deliver accurate dispersion control, while a deep LF performance is derived from the bass-reflex design. Three point rigging systems are integrated into the arrayable cabinets, even the cardioid subwoofer, these, together with ground stacking options, present an abundance of opportunity for deployment. The **Yi loudspeakers** differ only

slightly in cabinet construction, finish and mounting hardware. They are intended for permanently installed performance spaces where the specification is rider driven by the artist or mix engineer's preferences. Both the Yi cabinets and mounting hardware can be properly colour matched to interior designs and weather protected for climatically hostile environments.

# The Y-Series

The **Y7P** and **Yi7P** as well as the **Y10P** and **Yi10P** point source loudspeakers both feature the same dipolar arrangement with two 8" drivers centered around a 1.4" HF compression driver mounted on a CD horn with 75° x 40° and 110° x 40° dispersion characteristics respectively. A rotatable horn enables deployment in either orientation, whilst an innovative bass-reflex and port design gives an increased LF performance. The high performance omnidirectional **B6** and **Bi6-SUB** feature a single 18" long excursion driver, intended for ground stacked applications only.



**Y7P, Y10P loudspeaker**



**Yi7P, Yi10P loudspeaker**



**B6 subwoofer**



**Bi6 subwoofer**



**Y8, Y12 loudspeaker**



**Yi8, Yi12 loudspeaker**



**Y subwoofer**



**Yi subwoofer**

The **Y8** and **Y12** and the installation specific **Yi8** and **Yi12** line array modules also share the same driver arrangement, with two 8" dipolar mounted drivers and a 1.4" HF driver combined with a central wave transformer. The advanced bass-reflex and port arrangement delivers full bandwidth capabilities with an extended LF output. Due to the dipolar arrangement of the LF drivers, a broadband, horizontal directivity control is maintained down to approximately 500 Hz for the different dispersion options, 80° for the Y8 and 120° for the Y12. The arrayable, cardioid **Y** and **Yi** both house two long excursion neodymium drivers, powered by a single amplifier channel. The 18" and 12" drivers arranged in an integrated cardioid setup, avoid unwanted energy behind the system.

All Y loudspeakers are finished with a PCP (Polyurea Cabinet Protection) coating that provides mobile systems with protection against impact and resistance to the adverse effects on cabinets caused by changing ambient outdoor conditions. The Yi cabinets feature an impact resistant paint finish; Weather Resistant and Special Colour options are available.

The d&b software offering aides the entire system setup process. The **d&b ArrayCalc simulation software** allows the virtual optimization of loudspeaker line arrays, point source and column loudspeakers as well as subwoofers and their adjustment to venue conditions. The **d&b NoizCalc immission modelling software** uses international standards to model noise immission from d&b loudspeaker systems. NoizCalc takes data from ArrayCalc and calculates the sound propagation towards the far field. The complete system configuration simulated in ArrayCalc is assimilated by the **d&b R1 Remote control software** into an intuitive graphical user interface to manage the amplifiers, and loudspeakers, from anywhere in the venue.

d&b amplifiers are specifically designed for use with d&b loudspeakers, and are at the heart of the d&b system approach. These devices contain extensive Digital Signal Processing capabilities to provide comprehensive loudspeaker management and specific switchable filter functions to precisely target the system response for a wide variety of applications. The four channel **D80** amplifier is intended for both mobile and installation applications requiring the highest Sound Pressure Levels. The installation specific four channel **30D** amplifier is intended for permanent integration within venues which require medium to high Sound Pressure Levels. These amplifiers all provide extensive user-definable equalization containing two 16-band equalizers with parametric, notch, shelving and asymmetric filters as well as delay capabilities of up to 10 seconds.

The **DS10 Audio network bridge** provides 16 AES3 outputs and interfaces between the Dante audio transport protocol and the d&b amplifiers.

The **DS100 Signal Engine** is based on a specialized rack mount 3 RU audio processor with Audinate Dante networking. It provides a 64 x 64 audio matrix with level and delay adjustments at all cross points. Additional software modules provide dynamic source positioning and emulated acoustics functions.

An extensive range of standardized transport solutions is offered for the Y-Series, consisting of touring cases, touring carts as well as transport lids. Complete cabling structures including multicores and breakouts are also available, alongside extensive mounting options. Amplifier Touring rack assemblies can be provided for either three D20 amplifiers, three D80 amplifiers, or six D80 amplifiers. The DS10 Audio network bridge can be supplied in these fully equipped system racks, which also house mains power distribution units, connector interfaces and all internal cabling.



**D80 amplifier**



**30D amplifier**



**DS10 Audio network bridge**



**DS100 Signal Engine**

# The Y7P loudspeaker

## The Yi7P loudspeaker

### Y7P/Yi7P loudspeaker

The compact, 2-way passive Y7P loudspeaker and Yi7P loudspeaker feature two 8" drivers in a dipole arrangement with a 1.4" compression driver mounted onto a rotatable CD horn. The Yi7P is the installation version of the Y7P loudspeaker and differs only in cabinet construction, finish and mounting hardware. Sophisticated horn geometry combined with the advanced bass-reflex port design delivers full bandwidth capabilities with an extended LF output. These point source, high performance cabinets offer 75° horizontal directivity matched with a vertical dispersion of 40°; the horn can be rotated by 90° to enable horizontal orientation.

The Y7P/Yi7P provide a broad variety of deployment possibilities, especially when used as a stand-alone full range system, or combined with other elements from the Y-Series, either ground stacked or flown.

The loudspeaker cabinets are constructed from marine plywood, the Y7P has an impact and weather protected PCP (Polyurea Cabinet Protection) finish, while the Yi7P has an impact resistant paint finish. The front of the loudspeaker cabinets are protected by a rigid metal grill. The Y7P cabinet incorporates a pair of handles whilst M10 threaded inserts are provided for attaching d&b rigging hardware.

### System data

Frequency response (-5 dB standard) ..... 59 Hz - 18 kHz  
 Frequency response (-5 dB CUT mode) ..... 118 Hz - 18 kHz  
 Max. sound pressure (1 m, free field)<sup>1</sup> .....  
 with D6/10D ..... 132 dB  
 with 30D/D20 ..... 135 dB  
 with D80 ..... 137 dB  
 Input level (100 dB SPL/1 m) ..... -17 dBu

### Loudspeaker data

Nominal impedance ..... 8 ohms  
 Power handling capacity (RMS/peak 10 ms) ..... 400/1600 W  
 Nominal dispersion angle (h x v) ..... 75° x 40°  
 Components ..... 2 x 8" driver with neodymium magnet  
 ..... 1.4" exit compression driver  
 ..... passive crossover network  
 Connections Y7P ..... 2 x NLT4 F/M  
 ..... optional 2 x NL4 or 2 x EP5  
 Connections Yi7P ..... 2 x NL4 and screw terminal block  
 Weight Y7P/Yi7P ..... 18 kg (40 lb)

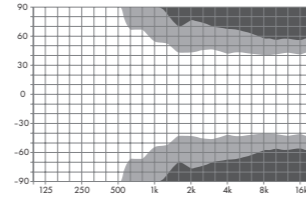

Y7P and Yi7P horizontal dispersion characteristics<sup>2</sup>

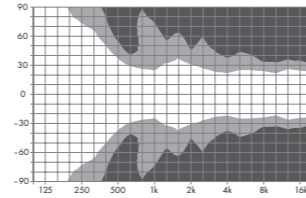

Y7P and Yi7P vertical dispersion characteristics<sup>2</sup>

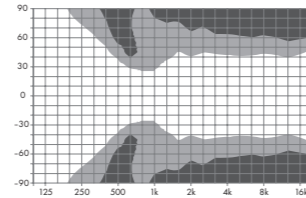

Y7P and Yi7P horizontal dispersion characteristics/horizontal setup, horn rotated<sup>2</sup>

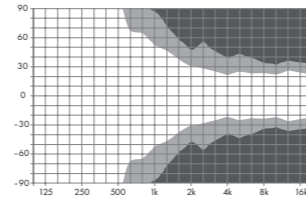

Y7P and Yi7P vertical dispersion characteristics/horizontal setup, horn rotated<sup>2</sup>

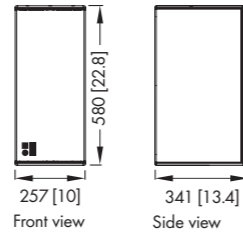

Front view

Side view

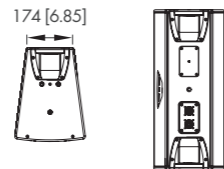

Top view

Rear view

Y7P cabinet dimensions in mm [inch]

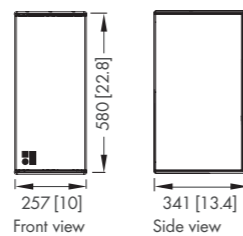

Front view

Side view

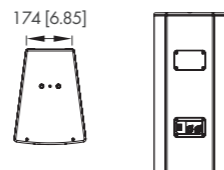

Top view

Rear view

Yi7P cabinet dimensions in mm [inch]

<sup>1</sup> Broadband measurement, pink noise, crest factor 4, peak measurement, linear weighting  
<sup>2</sup> Dispersion angle vs frequency plotted using lines of equal sound pressure (isobars) at -6 dB and -12 dB

# The Y10P loudspeaker

## The Yi10P loudspeaker

### Y10P/Yi10P loudspeaker

The compact, 2-way passive Y10P loudspeaker and Yi10P loudspeaker feature two 8" drivers in a dipole arrangement with a 1.4" compression driver mounted onto a rotatable CD horn. The Yi10P is the installation version of the Y10P loudspeaker and differs only in cabinet construction, finish and mounting hardware. Sophisticated horn geometry combined with the advanced bass-reflex port design delivers full bandwidth capabilities with an extended LF output. These point source, high performance cabinets offer 110° horizontal directivity matched with a vertical dispersion of 40°; the horn can be rotated by 90° to enable horizontal orientation.

The Y10P/Yi10P provide a broad variety of deployment possibilities, especially when used as a stand-alone full range system, or combined with other elements from the Y-Series, either ground stacked or flown.

The loudspeaker cabinets are constructed from marine plywood, the Y10P has an impact and weather protected PCP (Polyurea Cabinet Protection) finish, while the Yi10P has an impact resistant paint finish. The front of the loudspeaker cabinets are protected by a rigid metal grill. The Y10P cabinet incorporates a pair of handles whilst M10 threaded inserts are provided for attaching d&b rigging hardware.

### System data

Frequency response (-5 dB standard) ..... 59 Hz - 18 kHz  
 Frequency response (-5 dB CUT mode) ..... 118 Hz - 18 kHz  
 Max. sound pressure (1 m, free field)<sup>1</sup> .....  
 with D6/10D ..... 131 dB  
 with 30D/D20 ..... 134 dB  
 with D80 ..... 136 dB  
 Input level (100 dB SPL/1 m) ..... -17 dBu

### Loudspeaker data

Nominal impedance ..... 8 ohms  
 Power handling capacity (RMS/peak 10 ms) ..... 400/1600 W  
 Nominal dispersion angle (h x v) ..... 110° x 40°  
 Components ..... 2 x 8" driver with neodymium magnet  
 ..... 1.4" exit compression driver  
 ..... passive crossover network  
 Connections Y10P ..... 2 x NLT4 F/M  
 ..... optional 2 x NL4 or 2 x EP5  
 Connections Yi10P ..... 2 x NL4 and screw terminal block  
 Weight Y10P/Yi10P ..... 18 kg (40 lb)

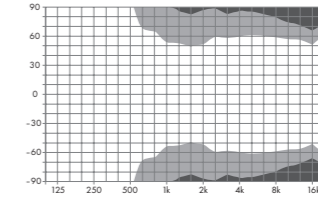

Y10P and Yi10P horizontal dispersion characteristics<sup>2</sup>

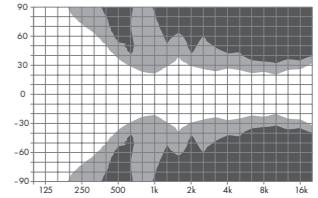

Y10P and Yi10P vertical dispersion characteristics<sup>2</sup>

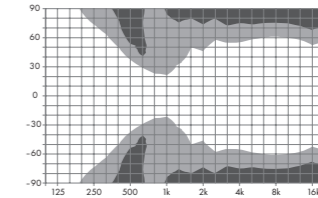

Y10P and Yi10P horizontal dispersion characteristics/horizontal setup, horn rotated<sup>2</sup>

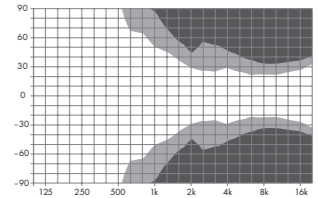

Y10P and Yi10P vertical dispersion characteristics/horizontal setup, horn rotated<sup>2</sup>

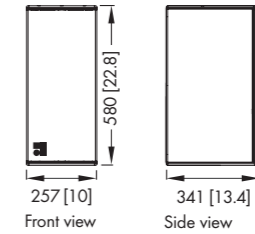

Front view

Side view

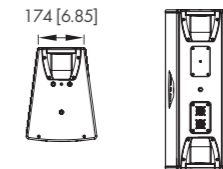

Top view

Rear view

Y10P cabinet dimensions in mm [inch]

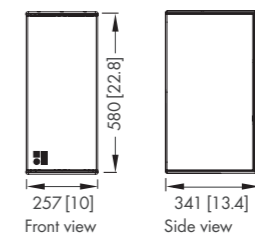

Front view

Side view

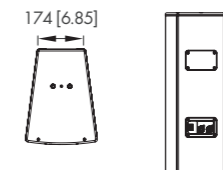

Top view

Rear view

Yi10P cabinet dimensions in mm [inch]

<sup>1</sup> Broadband measurement, pink noise, crest factor 4, peak measurement, linear weighting  
<sup>2</sup> Dispersion angle vs frequency plotted using lines of equal sound pressure (isobars) at -6 dB and -12 dB

# The B6 subwoofer

## The Bi6 subwoofer

### B6/Bi6 subwoofer

The B6-SUB and Bi6-SUB are high performance subwoofers designed for ground stacked applications, housing a long excursion 18" driver built into a bass-reflex design. The Bi6-SUB is the installation version of the B6 subwoofer and differs only in cabinet construction, finish and mounting hardware.

When three or any multiple of three B6 or Bi6 subwoofers are used, they can be positioned in a Cardioid Subwoofer Array, achieving exceptional directivity control in lower frequencies and significantly reducing the energy radiating towards the rear. The cabinets are constructed from marine plywood, the B6-SUB has an impact and weather protected PCP (Polyurea Cabinet Protection) finish, while the Bi6-SUB has an impact resistant paint finish. The front of the loudspeaker cabinet is protected by a rigid metal grill backed by an acoustically transparent foam. The side panels of the B6-SUB incorporate two handles, whilst four wheels are mounted to the rear and the enclosure features two runners to protect the bottom panel from scratching. Two correspondingly shaped recesses are incorporated into the top panel of each B6-SUB cabinet to accept these runners, preventing cabinet movement when stacked. An M20 threaded flange in the top panel accepts the d&b Loudspeaker stand winder M20.

### System data

Frequency response (-5 dB standard) ..... 37 Hz - 140 Hz  
 Frequency response (-5 dB 100 Hz mode) ..... 37 Hz - 110 Hz  
 Max. sound pressure (1 m, free field)<sup>1</sup> .....  
 with D6/10D ..... 128 dB  
 with 30D/D20 ..... 131 dB  
 with D80 ..... 134 dB

### Loudspeaker data

Nominal impedance ..... 8 ohms  
 Power handling capacity (RMS/peak 10 msec) ..... 500/2000 W  
 Components ..... 1 x 18" driver  
 Connections B6 ..... 2 x NLT4 F/M  
 ..... optional 2 x NL4 or 2 x EP5  
 Connections Bi6 ..... 2 x NL4 and screw terminal block  
 Weight B6/Bi6 ..... 41/38 kg (90/84 lb)

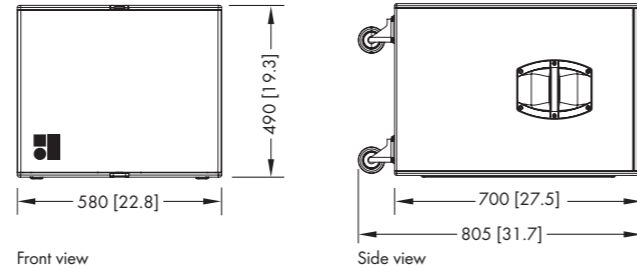

Front view

Side view

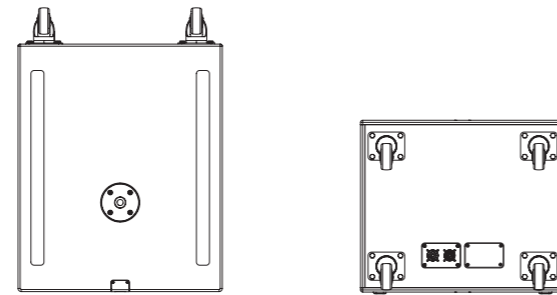

Top view

Rear view

B6-SUB cabinet dimensions in mm [inch]

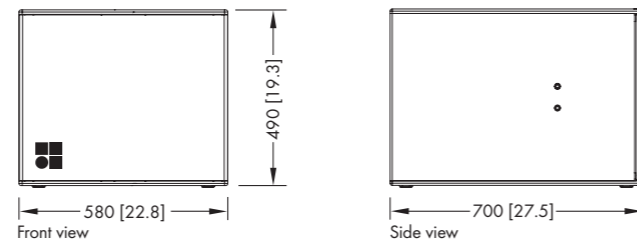

Front view

Side view

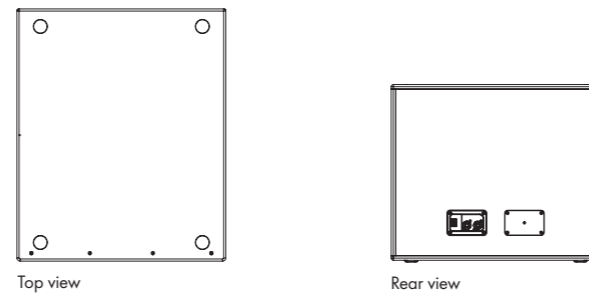

Top view

Rear view

Bi6-SUB cabinet dimensions in mm [inch]

# The Y7P, Y10P and B6 transport accessories

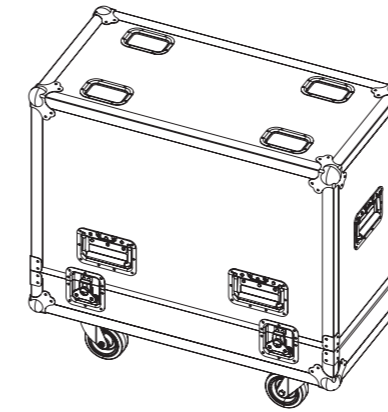

**E7473**  
**Touring case 2 x Y7P/Y10P**  
 Dimensions (H x W x D):  
 775 x 812 x 417 mm  
 30.5 x 32 x 16.4 inch  
 Net weight: 38 kg (84 lb)

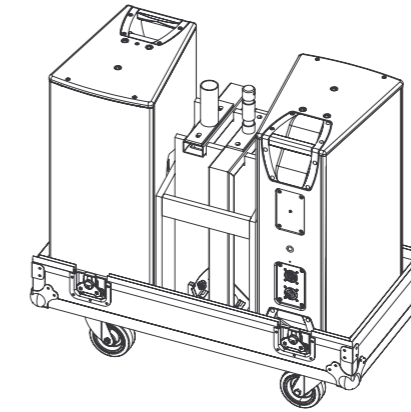

**E7925**  
**B6-SUB Transport lid**

# The Y8 loudspeaker The Yi8 loudspeaker

## Y8/Yi8 loudspeaker

The compact Y8 and Yi8 line array loudspeakers are designed for use in vertical columns. The 2-way passive design features two 8" drivers in a dipole arrangement and a centrally mounted 1.4" compression driver with a wave transformer. The Yi8 is the installation version of the Y8 loudspeaker and differs only in cabinet construction, finish and mounting hardware.

Sophisticated horn geometry combined with the advanced bass-reflex port design delivers full bandwidth capabilities with an extended LF output. These high performance line array modules offer 80° horizontal directivity controlled down to 500 Hz.

The mechanical and acoustical design enables vertical arrays of up to twenty four loudspeakers with vertical splay angles from 0° to 14° with a 1° resolution. It can be used in columns of purely Y8 loudspeaker or Yi8 loudspeaker or combined with Y12/Yi12 and/or Y-SUB/Yi-SUB cabinets.

The loudspeaker cabinets are constructed from marine plywood, the Y8 has an impact and weather protected PCP (Polyurea Cabinet Protection) finish, while the Yi8 has an impact resistant paint finish. The front of the loudspeaker cabinet is protected by a rigid metal grill backed by an acoustically transparent foam. Each side panel of the Y8 incorporates a handle while two additional recessed grips are provided at the rear. Three point rigging hardware is integrated into the loudspeaker enclosure.

### System data

Frequency response (-5 dB standard)	54 Hz - 19 kHz
Frequency response (-5 dB CUT mode)	100 Hz - 19 kHz
Max. sound pressure (1 m, free field) <sup>1</sup>	
with D6/10D	134 dB
with 30D/D20	137 dB
with D80	139 dB

### Loudspeaker data

Nominal impedance	8 ohms
Power handling capacity (RMS/peak 10 ms)	400/1600 W
Nominal dispersion angle (h)	80°
Splay angle settings	0° - 14° (1° increment)
Components	2 x 8" driver with neodymium magnet 1.4" exit compression driver passive crossover network
Connections Y8	2 x NLT4 F/M
	optional 2 x NL4 or 2 x EP5
Connections Yi8	2 x NL4 and screw terminal block
Weight Y8/Yi8	20 kg (44 lb)

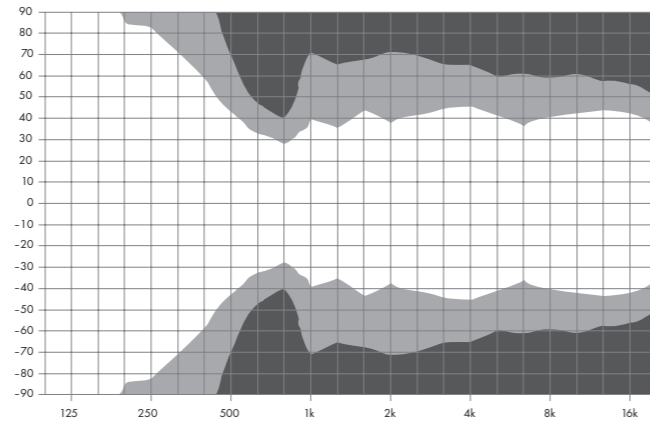

Y8 and Yi8 horizontal dispersion characteristics<sup>2</sup>

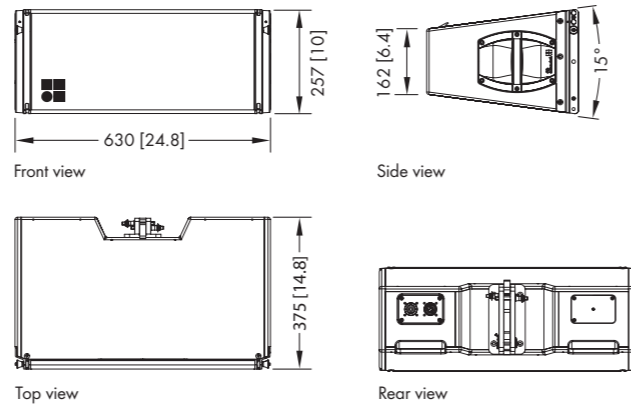

Y8 cabinet dimensions in mm [inch]

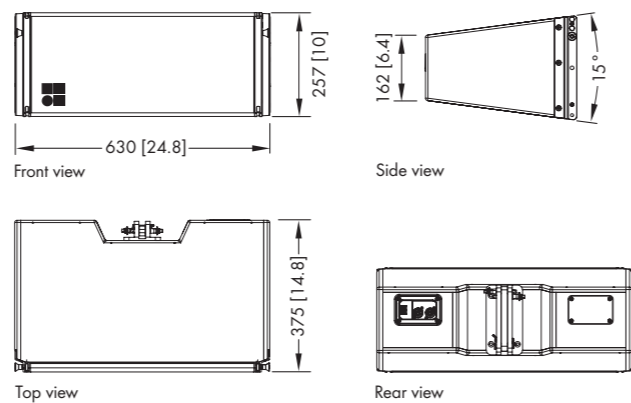

Yi8 cabinet dimensions in mm [inch]

<sup>1</sup> Broadband measurement, pink noise, crest factor 4, peak measurement, linear weighting  
<sup>2</sup> Dispersion angle vs frequency plotted using lines of equal sound pressure (isobars) at -6 dB and -12 dB

# The Y12 loudspeaker The Yi12 loudspeaker

## Y12/Yi12 loudspeaker

The compact Y12 and Yi12 line array loudspeakers are designed for use in vertical columns. The 2-way passive design features two 8" drivers in a dipole arrangement and a centrally mounted 1.4" compression driver with a wave transformer. The Yi12 is the installation version of the Y12 loudspeaker and differs only in cabinet construction, finish and mounting hardware. Sophisticated horn geometry combined with the advanced bass-reflex port design delivers full bandwidth capabilities with an extended LF output. These high performance line array modules offer 120° horizontal directivity controlled down to 500 Hz.

The mechanical and acoustical design enables vertical arrays of up to twenty four loudspeakers with vertical splay angles from 0° to 14° with a 1° resolution. It can be used in columns of purely Y12 loudspeaker or Yi12 loudspeaker or combined with Y8/Yi8 and/or Y-SUB/Yi-SUB cabinets.

The loudspeaker cabinets are constructed from marine plywood, the Y12 has an impact and weather protected PCP (Polyurea Cabinet Protection) finish, while the Yi12 has an impact resistant paint finish. The front of the loudspeaker cabinet is protected by a rigid metal grill backed by an acoustically transparent foam. Each side panel of the Y12 incorporates a handle while two additional recessed grips are provided at the rear. Three point rigging hardware is integrated into the loudspeaker enclosure.

### System data

Frequency response (-5 dB standard)	54 Hz - 19 kHz
Frequency response (-5 dB CUT mode)	100 Hz - 19 kHz
Max. sound pressure (1 m, free field) <sup>1</sup>	
with D6/10D	134 dB
with 30D/D20	137 dB
with D80	139 dB

### Loudspeaker data

Nominal impedance	8 ohms
Power handling capacity (RMS/peak 10 ms)	400/1600 W
Nominal dispersion angle (h)	120°
Splay angle settings	0° - 14° (1° increment)
Components	2 x 8" driver with neodymium magnet 1.4" exit compression driver passive crossover network
Connections Y12	2 x NLT4 F/M
	optional 2 x NL4 or 2 x EP5
Connections Yi12	2 x NL4 and screw terminal block
Weight Y12/Yi12	20 kg (44 lb)

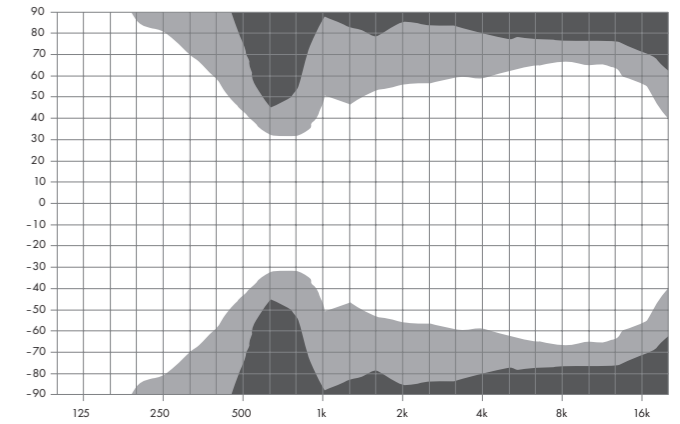

Y12 and Yi12 horizontal dispersion characteristics<sup>2</sup>

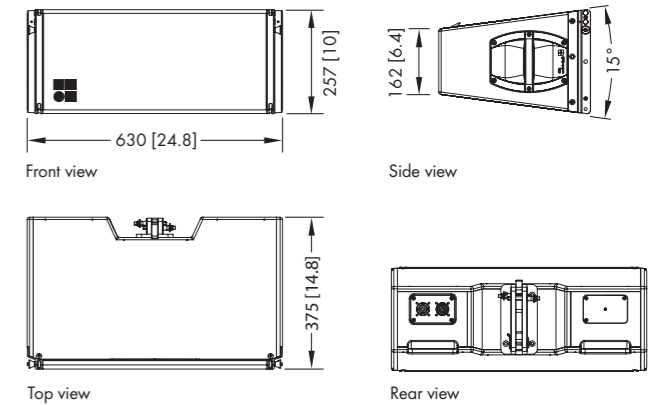

Y12 cabinet dimensions in mm [inch]

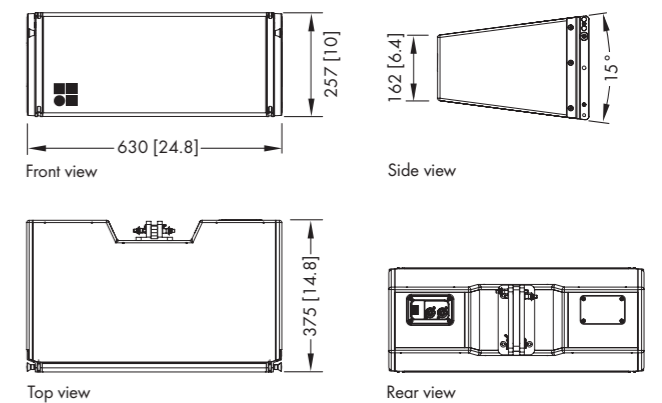

Yi12 cabinet dimensions in mm [inch]

<sup>1</sup> Broadband measurement, pink noise, crest factor 4, peak measurement, linear weighting  
<sup>2</sup> Dispersion angle vs frequency plotted using lines of equal sound pressure (isobars) at -6 dB and -12 dB



# The Y subwoofer

## The Yi subwoofer

### Y/Yi subwoofer

The Y-SUB and Yi-SUB are actively driven cardioid subwoofers powered by a single amplifier channel. The Yi-SUB is the installation version of the Y-SUB and differs only in cabinet construction, finish and mounting hardware. They house two long excursion neodymium drivers in an integrated cardioid setup, an 18" driver in a bass-reflex chamber facing to the front and a 12" driver in a two chamber bandpass design radiating towards the rear.

The cardioid dispersion pattern resulting from this arrangement avoids the distribution of energy behind the system, providing the greatest accuracy of low frequency reproduction and reducing the energy dispersed into unwanted areas. The Y-SUB and Yi-SUB are fitted with three point rigging hardware and can be flown in columns of purely Y or Yi subwoofers, at the top of a Y/Yi array or used in a ground stacked setup.

The cabinets are constructed from marine plywood, the Y-SUB has an impact and weather protected PCP (Polyurea Cabinet Protection) finish while the Yi-SUB has an impact resistant paint finish. The front of the loudspeaker cabinet is protected by a rigid metal grill backed by an acoustically transparent foam, whilst the side panels of the Y-SUB incorporate four handles with four wheels mounted to the rear.

### System data

Frequency response (-5 dB standard) .....	39 Hz - 140 Hz
Frequency response (-5 dB 100 Hz mode) .....	39 Hz - 110 Hz
Max. sound pressure (1 m, free field) <sup>1</sup> .....	
with D6/10D .....	128 dB
with 30D/D20 .....	131 dB
with D80 .....	134 dB

### Loudspeaker data

Nominal impedance .....	8 ohms
Power handling capacity (RMS/peak 10 ms) .....	600/2400 W
Splay angle settings .....	0° and 2.5°
Components .....	1 x 18" driver with neodymium magnet
.....	1 x 12" driver with neodymium magnet
Connections Y-SUB .....	2 x NLT4 F/M
.....	optional 2 x NL4 or 2 x EP5
Connections Yi-SUB .....	2 x NL4 and screw terminal block
Weight Y-SUB/Yi-SUB .....	52/49 kg (115/108 lb)

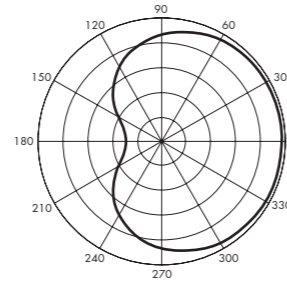

Cardioid polar pattern

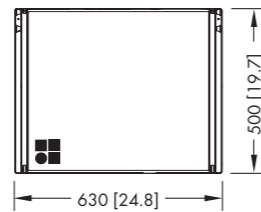

Front view

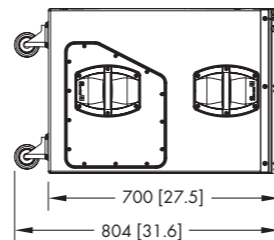

Side view

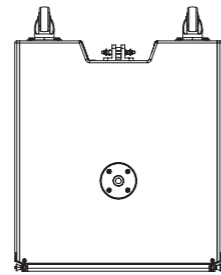

Top view

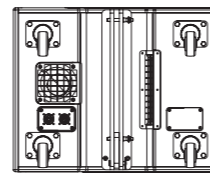

Rear view

Y-SUB cabinet dimensions in mm [inch]

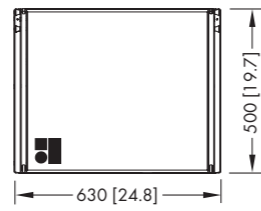

Front view

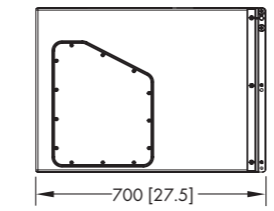

Side view

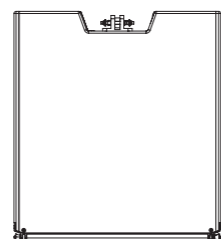

Top view

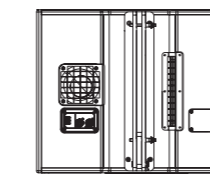

Rear view

Yi-SUB cabinet dimensions in mm [inch]

# The Y8, Y12 and Y-SUB transport accessories

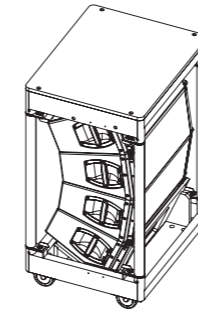

E7470

### Touring cart 4 x Y8/Y12

Dimensions (H x W x D):  
1200 x 600 x 730 mm  
47.3 x 23.7 x 29 inch  
Total weight: 130 kg (285 lb)  
Max. top load: 100 kg (220 lb)

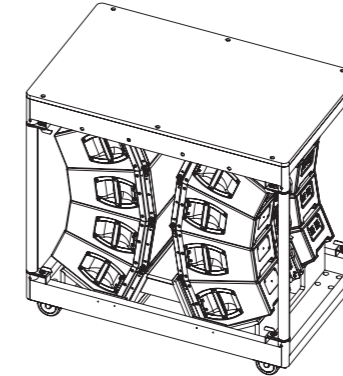

E7471

### Touring cart 8 x Y8/Y12

Dimensions (H x W x D):  
1200 x 1200 x 730 mm  
47.3 x 47.3 x 29 inch  
Total weight: 230 kg (510 lb)  
Max. top load: 200 kg (440 lb)

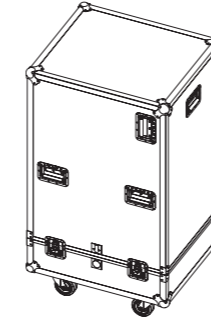

E7472

### Touring case 4 x Y8/Y12

Dimensions (H x W x D):  
1271 x 724 x 626 mm  
50 x 28.5 x 24.6 inch  
Net weight: 61 kg (135 lb)

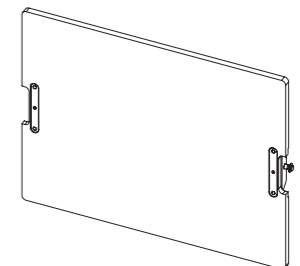
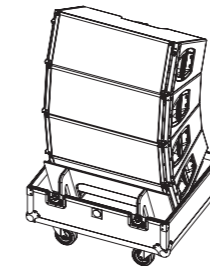

E7924

### Y-SUB Transport lid

E7475

### Touring case 2 x Y Flying frame

Dimensions (H x W x D):  
962 x 724 x 628 mm  
38 x 28.5 x 24.7 inch  
Net weight: 51 kg (112 lb)

# The Y7P, Y10P and B6-SUB mounting accessories

# The Y7P, Y10P and B6-SUB mounting examples

## Safety approval

d&b loudspeakers and accessories are designed for setup and use within situations requiring compliance with the provisions and directives of the DGUV regulation 17 (formerly BGV C1).

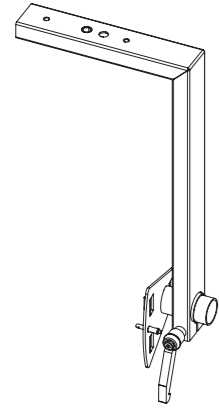

**Z5397**  
YP Swivel bracket

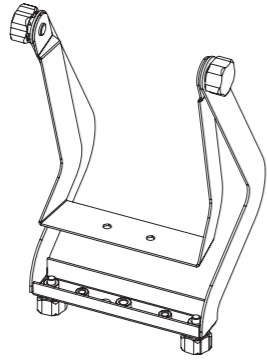

**Z5399**  
YP Mounting bracket

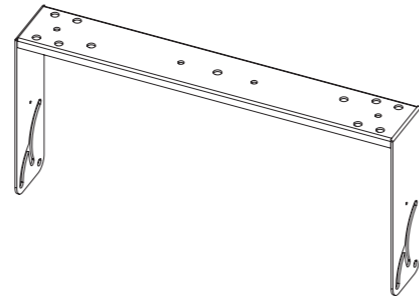

**Z5398**  
YP Horizontal bracket

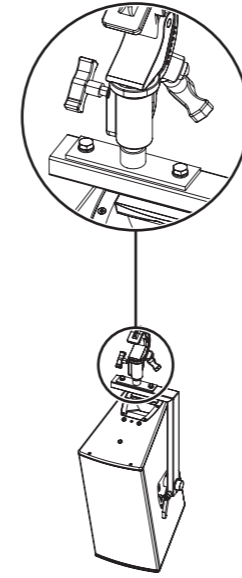

**Y7P/Y10P with**  
**Z5397 YP Swivel bracket**  
**Z5010 TV Spigot with fixing plate**  
**Z5012 Pipe clamp**

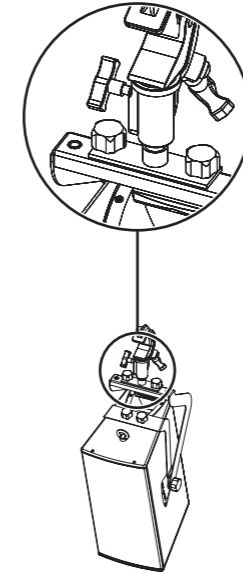

**Y7P/Y10P with**  
**Z5399 YP Mounting bracket**  
**Z5010 TV Spigot with fixing plate**  
**Z5012 Pipe clamp**

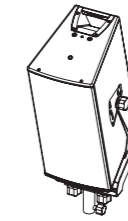

**Y7P/Y10P with**  
**Z5399 YP Mounting bracket**  
**Z5024 Loudspeaker stand adapter**

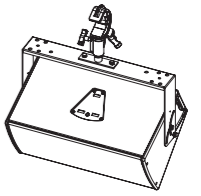

**Y7P/Y10P with**  
**Z5398 YP Horizontal bracket**  
**Z5010 TV Spigot with fixing plate**  
**Z5012 Pipe clamp**

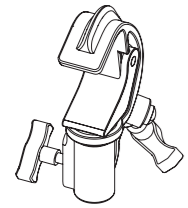

**Z5012**  
Pipe clamp for TV Spigot  
For a tube diameter up to  
70 mm/2.75"

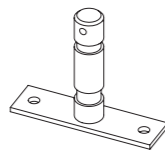

**Z5010**  
TV Spigot with fixing plate

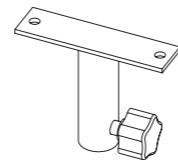

**Z5024**  
Loudspeaker stand adapter

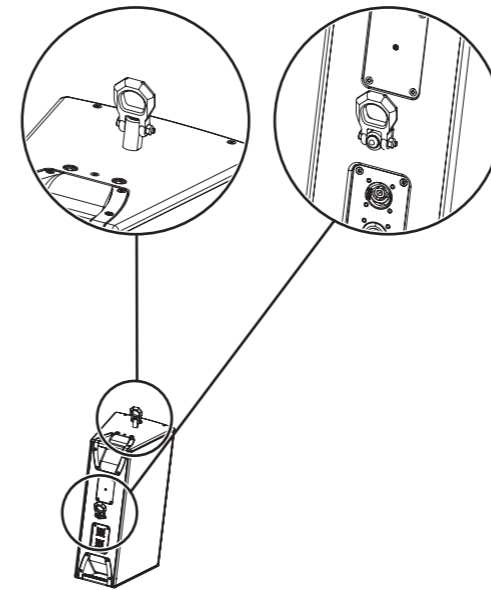

**Y7P/Y10P with**  
**2 x Z5049 Flying pin 8mm**

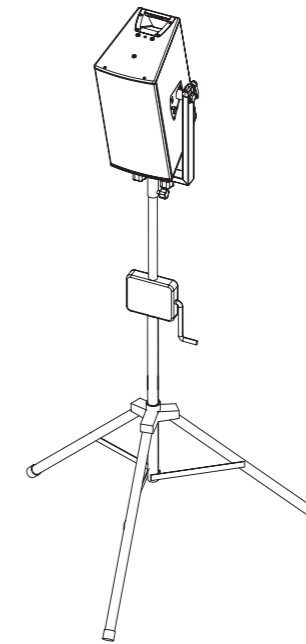

**Y7P/Y10P with**  
**Z5397 YP Swivel bracket**  
**Z5009 Loudspeaker stand with winder**  
**Z5024 Loudspeaker stand adapter**

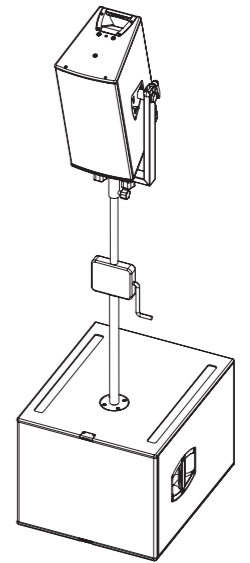

**Y7P/Y10P with**  
**Z5397 YP Swivel bracket**  
**Z5013 Loudspeaker stand winder M20**  
**Z5024 Loudspeaker stand adapter**



**Z5049**  
Flying pin 8mm<sup>1</sup>

# The Yi7P, Yi10P and Bi6-SUB mounting accessories

# The Yi7P, Yi10P and Bi6-SUB mounting examples

## Safety approval

d&b loudspeakers and accessories are designed for setup and use within situations requiring compliance with the provisions and directives of the DGUV regulation 17 (formerly BGV C1).

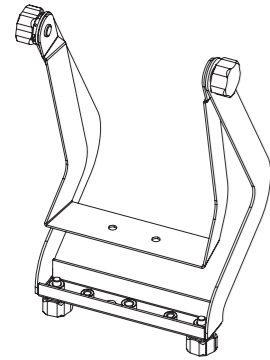

**Z5399**  
YP Mounting bracket

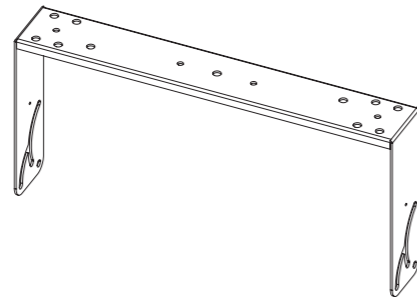

**Z5398**  
YP Horizontal bracket

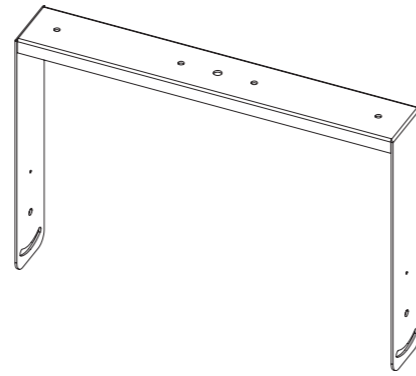

**Z5389**  
Bi6-SUB Horizontal bracket

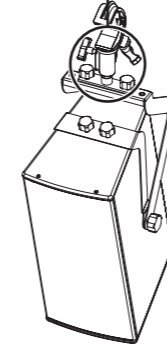
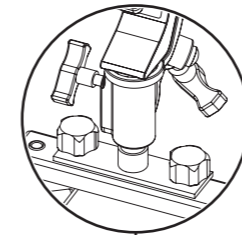

**Yi7P/Yi10P with**  
**Z5399 YP Mounting bracket**  
**Z5010 TV Spigot with fixing plate**  
**Z5012 Pipe clamp**

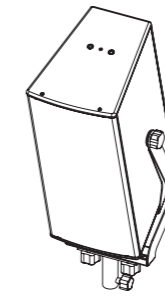

**Yi7P/Yi10P with**  
**Z5399 YP Mounting bracket**  
**Z5024 Loudspeaker stand adapter**

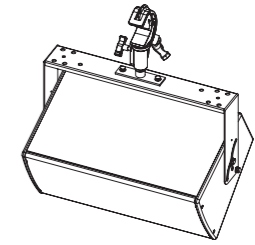

**Yi7P/Yi10P with**  
**Z5398 YP Horizontal bracket**  
**Z5010 TV Spigot with fixing plate**  
**Z5012 Pipe clamp**

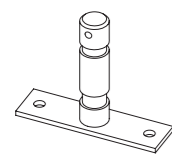

**Z5010**  
TV Spigot with fixing plate

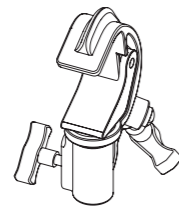

**Z5012**  
Pipe clamp for TV Spigot  
For a tube diameter up to  
70 mm/2.75"

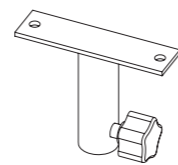

**Z5024**  
Loudspeaker stand adapter

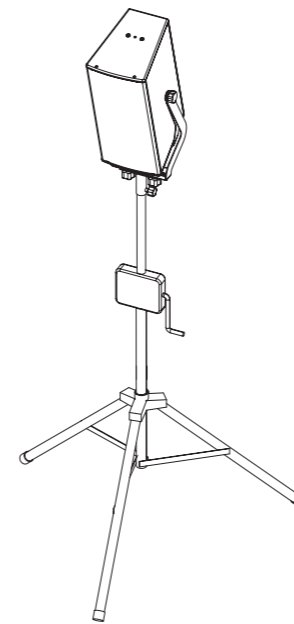

**Yi7P/Yi10P with**  
**Z5399 YP Mounting bracket**  
**Z5009 Loudspeaker stand with winder**

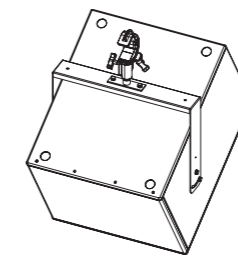

**Bi6-SUB with**  
**Z5389 Bi6 Horizontal bracket**  
**Z5010 TV Spigot with fixing plate**  
**Z5012 Pipe clamp**

# The Y8/Yi8, Y12/Yi12 and Y/Yi-SUB rigging accessories

# The Y8, Y12 and Y-SUB rigging examples

## Safety approval

d&b loudspeakers and accessories are designed for setup and use within situations requiring compliance with the provisions and directives of the DGUV regulation 17 (formerly BGV C1).

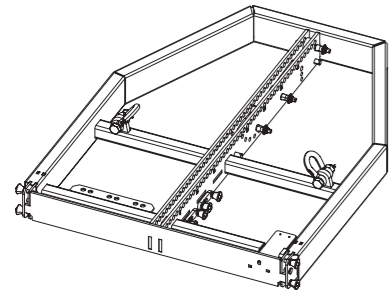

**Z5390  
Y Flying frame**  
For a maximum of twenty four Y8/Y12/Yi8/Yi12 loudspeakers or ten Y/Yi subwoofers

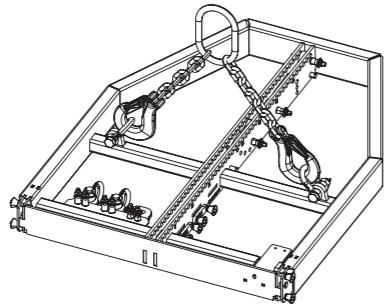

**Z5390  
Y Flying frame**  
Supplied with  
1 x Z5392 Y Safety chainset  
2 x Y Load adapter  
1 x Y Load adapter for rota clamp  
2 x Front link

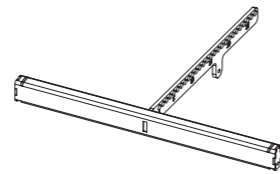

**Z5394  
Y Flying adapter**  
For a maximum of six Y8/Y12 loudspeakers; supplied with 1t Shackle

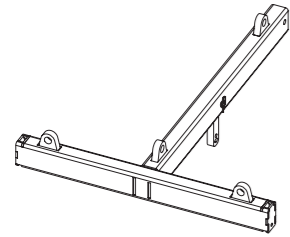

**Z5393.000  
Y Mounting frame top**  
For a maximum load equivalent to six Yi8/Yi12 loudspeakers

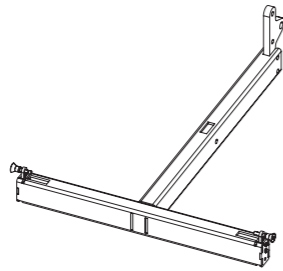

**Z5393.001  
Y Mounting frame bottom**

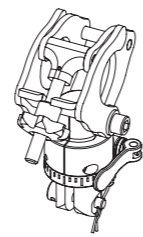

**Z5147  
Rota clamp**  
WLL: 500 kg (1100 lb) for a tube diameter up to 51 mm/2"



**Z5392  
Y Safety chainset**



**Z5391  
Y Hoist connector chain**



**E6507  
1t Shackle**

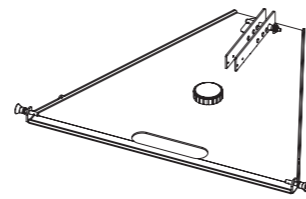

**Z5396  
Y Base plate**

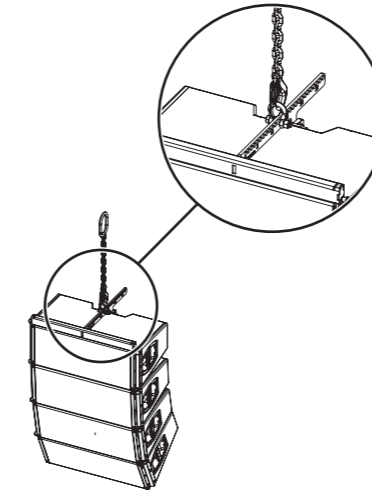

**Y8/Y12 array with  
Z5394 Y Flying adapter  
Z5391 Y Hoist connector chain**

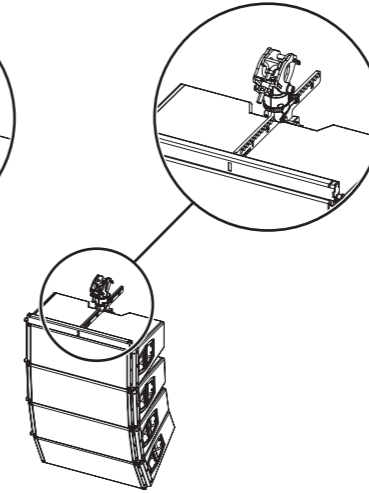

**Y8/Y12 array with  
Z5394 Y Flying adapter  
Z5147 Rota clamp**

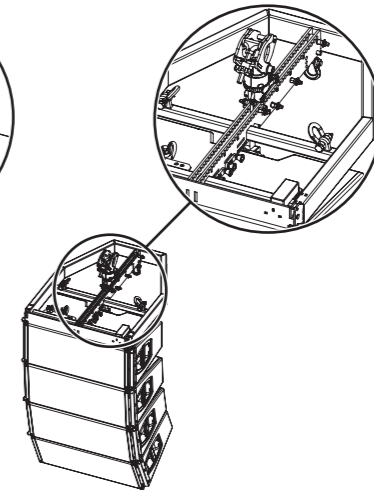

**Y8/Y12 array with  
Z5390 Y Flying frame  
Z5147 Rota clamp**

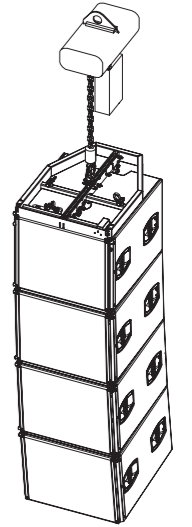

**Y-SUB column with  
Z5390 Y Flying frame**

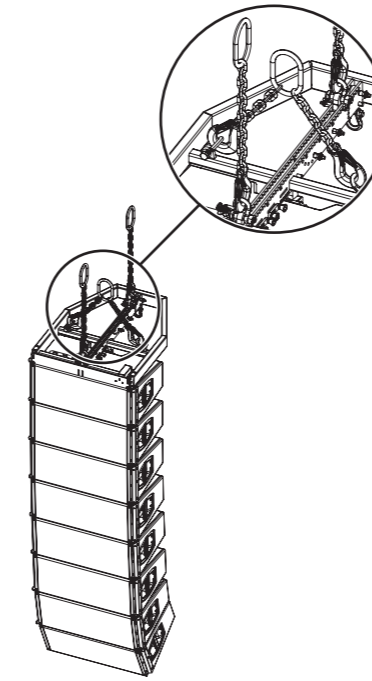

**Y8/Y12 array with  
Z5390 Y Flying frame  
2 x Z5391 Y Hoist connector chain  
Z5392 Y Safety chainset**

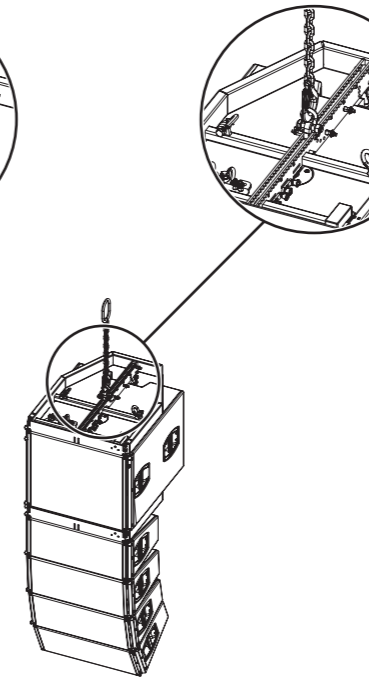

**Y-Series array with  
Z5390 Y Flying frame  
Z5391 Y Hoist connector chain**

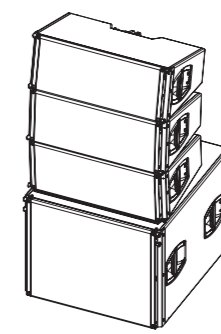

**Y-Series ground stack with  
Z5396 Y Base plate**

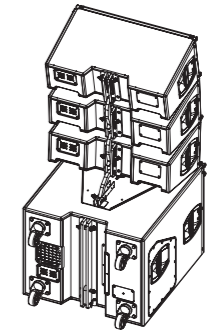

# The Yi8, Yi12 and Yi-SUB rigging examples

# The Yi Weather Resistant and Special Colour options

## Safety approval

d&b loudspeakers and accessories are designed for setup and use within situations requiring compliance with the provisions and directives of the DGUV regulation 17 (formerly BGV C1).

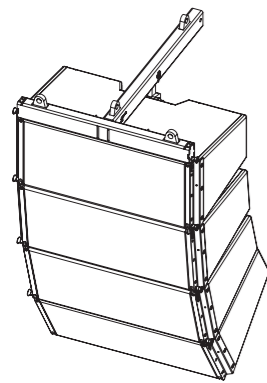

Yi8/Yi12 array with  
Z5393.000 Y Mounting frame top

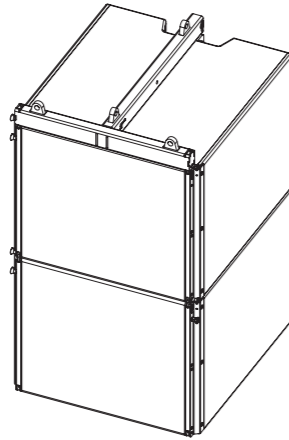

Yi-SUB column with  
Z5393.000 Y Mounting frame top

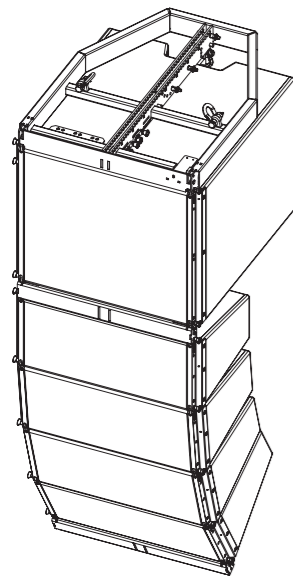

Yi array with  
Z5390 Y Flying frame  
2 x Z5393.001 Y Mounting frame bottom

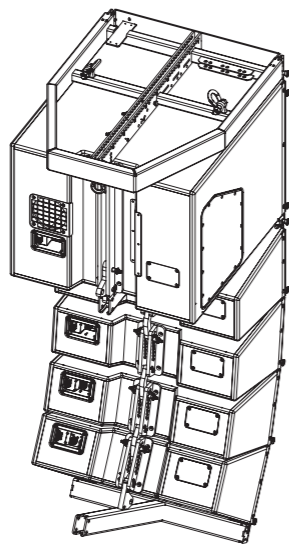

The Yi cabinets and appropriate accessories are also available with a Weather Resistant or Special Colour option. Both options can be combined.

## Weather Resistant (WR) option

The WR option enables operation of loudspeakers in changing ambient conditions, however it is not intended to enable permanent, unprotected operation of loudspeakers outdoors. A cover must also be positioned over the loudspeakers. Cabinets used outdoors even with the WR option should always be aimed either horizontally or with a downward tilt. The Yi-SUB should always be positioned without any vertical tilt. Yi loudspeakers with the Weather Resistant option are supplied with a fixed cable. PG cable type H07RN-F 2 x 2.5 mm<sup>2</sup>/AWG 13 with a length of 5.5 m (18 ft) as standard or length as required. Additionally, the Yi loudspeakers supplied with the WR option, based on a PCP finish (Polyurea Cabinet Protection), are also available in RAL colour versions.

## Special Colour (SC) option

The paint finish of all loudspeaker cabinets and most accessories can be executed in almost all RAL colours in accordance with the RAL colour table. All rigging fittings at the rear of the cabinet, Front links and Locking pins remain in black. Other paint finishes such as metallic are available on request. The acoustically transparent foam fitted behind the rigid metal grill is also painted with the requested RAL colour.

# The d&b ArrayCalc simulation software

The d&b ArrayCalc simulation software is the prediction tool for d&b line arrays, column and point source loudspeakers as well as subwoofers. This is a comprehensive toolbox for all tasks associated with acoustic design, performance prediction, alignment, rigging and safety parameters. For safety reasons d&b line arrays must be designed using the d&b ArrayCalc simulation software. ArrayCalc is available as a native stand-alone application for both Microsoft Windows<sup>1</sup> (Win7 or higher) and Mac OS X<sup>2</sup> (10.7 or higher) operating systems. In combination with the d&b Remote Network, this can significantly reduce setup and tuning time in mobile applications and allows for precise simulations when planning installations. Listening planes can be defined in the venue tab, creating a three dimensional representation of any audience area in a given venue. This can also include balconies, side stalls, arenas, in the round scenarios or festivals. Special functions assist in obtaining accurate dimensions with laser distance finders and inclinometers.

## Simulation

Up to fourteen flown arrays or subwoofer columns can be defined in a project file as single hangs or in pairs. A selection of d&b point source loudspeakers can also be fully integrated as well as a ground stacked SUB array consisting of up to fifty one positions. All can be freely positioned according to their intended application, for example as main hang, outfill, nearfill or delay. Position, orientation, aiming and coverage details are displayed. Level over distance is calculated for each source with high resolution in real time, for either band limited or broadband input signals. The comprehensive simulation precisely models the actual performance of the system, taking into account input level, all system configuration options (such as CUT, CPL, HFC or INFRA), limiter headroom and air absorption. Acoustic obstacles, such as video screens, can be added to a model. Acoustic shadowing, whether by these obstacles, or a balcony overhang, is taken into consideration. The load status of all array rigging components is calculated accurately and displayed to determine whether a given array is within the load tolerance. Subwoofer array design is assisted by coverage and polar plot prediction. A specialized algorithm allows the user to specify subwoofer positions and a coverage angle, which is then converted into appropriate delay settings that result in the desired dispersion. The alignment tab enables different sources to be time aligned to one another, as well as showing arrival times and Sound Pressure Levels at a definable reference point on one of the audience areas. For alignment of the flown system with the ground stacked SUB array, the phase response of both the SUB array and a flown source is calculated at a definable reference point.

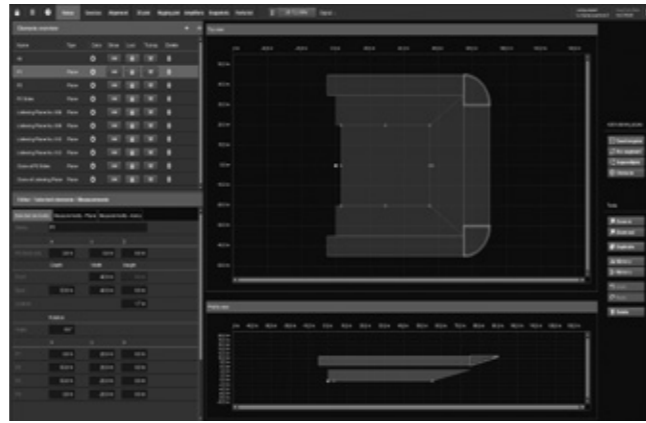

Venue

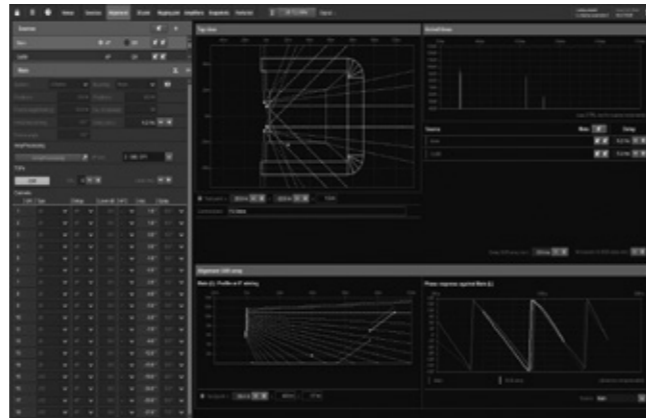

Alignment

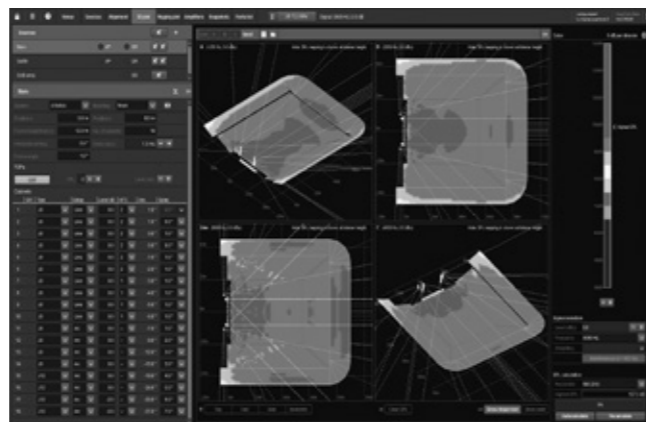

3D Plot quad

Both simulations reflect changes in delay time to the single sources in real time. The d&b ArrayCalc simulation software is available at [www.dbaudio.com](http://www.dbaudio.com), along with further information and video tutorials.

## Prediction

The level distribution resulting from the interaction of all active sources can be mapped onto the audience areas in a three-dimensional view, which can also be zoomed, rotated and exported as a graphics file. EASE and DXF data export capabilities are also available. A rigging plot with all necessary coordinates, dimensions and weights of arrays is generated for export and printing and a parts list, detailing all components required. The d&b ArrayCalc Viewer app presents this key information for positioning and flying a d&b audiotechnik loudspeaker system on a mobile device. Once the system has been designed, calculated and optimized, all relevant project information can be shared via email, AirDrop, or downloaded onto any iOS or Android device.

## ArrayProcessing

The optional ArrayProcessing function applies powerful filter algorithms to optimize the tonal (spectral) and level (spatial) performance of a line array column over the audience area defined by its mechanical vertical coverage angle. Within the d&b ArrayCalc simulation software, spectral and level performance targets over the listening areas can be defined while specific level drops or offsets can be applied to certain areas, to assign reduced level zones. ArrayProcessing applies a combination of FIR and IIR filters to each individual cabinet in an array to achieve the targeted performance, with an additional latency of only 5.9 ms. This significantly improves the linearity of the response over distance as well as seamlessly correcting for air absorption. In addition, ArrayProcessing employs the same frequency response targets for all d&b line arrays, to ensure all systems share a common tonality. This provides consistent sonic results regardless of array length or splay settings. The resulting coverage is enhanced with spectral consistency and defined level distribution, achieving more linear dispersion and total system directivity to cover longer distances or steep listening areas effectively.

## R1 Remote Control Software

R1 uses the same project file created by ArrayCalc and generates an intuitive graphical user interface including complete details of the simulated system, loudspeakers, amplifiers, remote IDs, groups, ArrayProcessing data and all configuration information. This workflow removes the need to manually transfer data from one software program to the other.

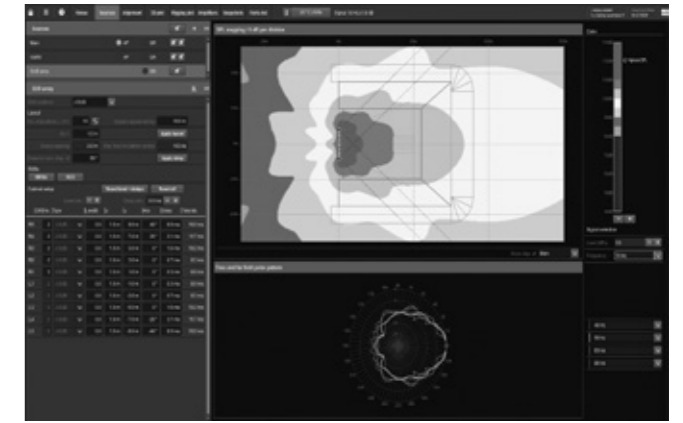

Sources, SUB array

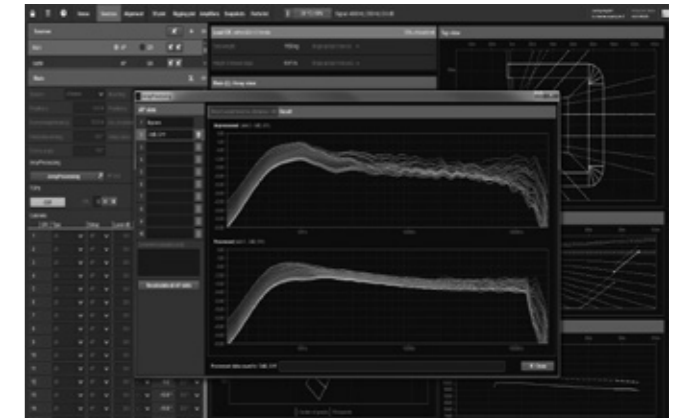

ArrayProcessing

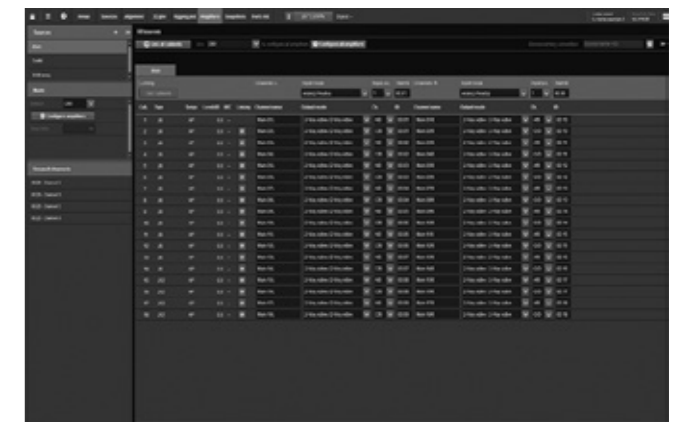

Amplifiers

<sup>1</sup> Microsoft Windows is a registered trademark or trademark of Microsoft Corporation in the United States and/or other countries

<sup>2</sup> Mac OS X is a trademark of Apple Inc., registered in the U.S. and other countries

# The d&b NoizCalc immission modelling software

The d&b software uses international standards to model the far field noise immission from multiple complex and coherently emitting sources such as line arrays and subwoofer arrays. Gaining permission and licenses to stage live open air events often requires an official statement with a prediction of how noise could impact on the surrounding area. Careful planning of the combined directivity and the direction can influence the immission result outside of the event area. NoizCalc takes all complex loudspeaker data and a reference point from the d&b ArrayCalc simulation software and calculates the sound propagation and relative attenuation values towards the far field for a certain scenario with particular meteorological conditions for one or more d&b loudspeaker systems.

The results are displayed on a 3D terrain map showing the calculated immission on the areas surrounding the audience listening zones. This visual representation shows the actual system performance in the far field, enabling users to optimize for listeners while satisfying local noise restrictions and offsite regulations. To ensure the results are reliable, NoizCalc includes all complex data concerning the addition and subtraction of sound waves, including phase information to describe the combination and interaction effects within a loudspeaker system consisting of multiple line arrays, subwoofer arrays and delay systems.

NoizCalc models immissions in the far field according to the internationally accepted ISO 9613-2 or Nord2000 calculation standards. Ground characteristics can be set depending on the absorbency or reflectivity of surfaces, while areas with volume attenuating properties can be defined. Buildings can be included, and the maximum reflection order option adjusts how many reflections are calculated. Parameters for humidity, air pressure and temperature ensure that the correct air absorption figures are accounted. The ISO 9613-2 standard requires limited meteorological information and assumes a worst case scenario. The more sophisticated propagation model, Nord2000 enables a more precise handling of meteorological conditions allowing the user to model with prevailing wind information. The d&b NoizCalc immission modelling software is available at [www.dbaudio.com](http://www.dbaudio.com) for registered download, along with further information and video tutorials. It was developed in collaboration with SoundPLAN, a specialist software developer for environmental noise prediction.



Editor

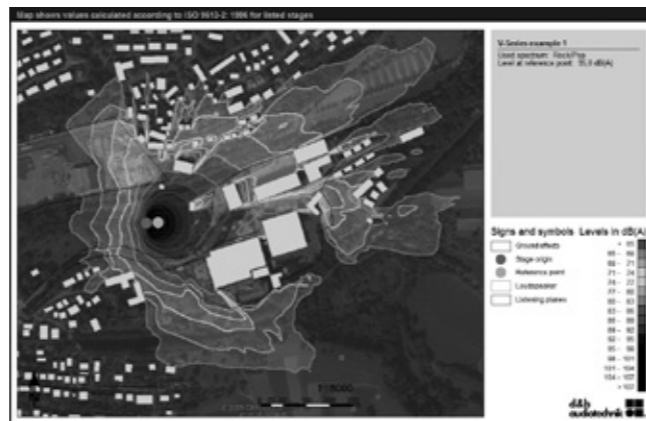

Graphic plot

# The d&b R1 Remote control software

The remote control capability of the d&b Remote network enables central control and monitoring of a complete d&b loudspeaker system from anywhere in the network, be it from a computer in the control room, at the mix position, or on a wireless tablet in the auditorium. This central access to all functions through the d&b Remote network, to controls as well as detailed system and device diagnostics information, unlocks the full potential of the d&b system approach. In a typical user workflow, the d&b Remote network takes settings optimized in the ArrayCalc Simulation Software and applies these to all the amplifiers within the network. R1 uses the same project file created by ArrayCalc allowing system configuration to be quickly accomplished, providing more time for verification and fine tuning.

All features, functions and controls available on the front panel of d&b amplifiers may be remotely controlled and/or monitored using the d&b R1 Remote control software. This allows each channel of the amplifier to be controlled and enables the creation of groups of loudspeakers. When grouped together, a button or fader can control the overall system level, zone level, equalization and delay, power ON/OFF, MUTE, as well as loudspeaker specific function switches such as CUT/HFA/HFC and CPL. An offline mode is provided for preparation in advance of an event, without the amplifiers being present or connected. d&b System check verifies that the system performs within a predefined condition, while the Array verification function automatically identifies the physical position of a loudspeaker in an array to check that the system is cabled correctly. Extensive facilities for storing and recalling system settings are provided allowing these to be repeated, as and when required. For mobile applications, project files can be easily adjusted for use with a different set of equipment at another location.

In installation projects system integrators can configure the d&b Remote Network to offer access to different levels of control, tailored to the operational demands. For example, power ON/OFF for daily use, or more complex functionality for detailed control. Password protection is available to restrict access. Input and Load monitoring allow installation operators to ensure optimum performance at all times. The d&b R1 Remote control software enables d&b amplifiers to be remotely controlled using both Ethernet and CAN-Bus in parallel. The software is optimized for use with touch screen, mouse and keyboard and runs on both Microsoft Windows<sup>1</sup> (Win7 or higher) and Mac OS X<sup>2</sup> (10.7 or higher) operating systems. Further information is provided in the d&b Amplifier and Software brochure which is available for download at [www.dbaudio.com](http://www.dbaudio.com).



Home



Remote in Configuration mode

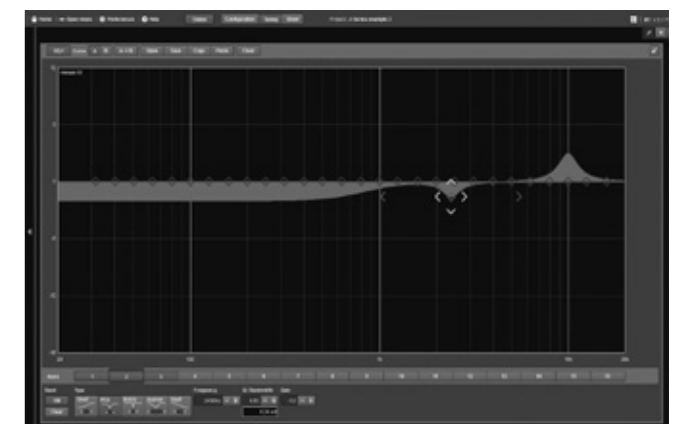

16-band equalizer

<sup>1</sup> Microsoft Windows is a registered trademark or trademark of Microsoft Corporation in the United States and/or other countries

<sup>2</sup> Mac OS X is a trademark of Apple Inc., registered in the U.S. and other countries

# The d&b amplifiers

The d&b amplifiers are designed specifically to power d&b loudspeakers and are the beating heart of the d&b System reality. As such, they incorporate Digital Signal Processing for comprehensive loudspeaker management, switchable filter functions, remote capabilities and user-definable controls, to fulfil the exact needs of each application. Every loudspeaker configuration combines comprehensive system limiting, and equalization and crossover settings to ensure consistent results and optimal performance. d&b amplifiers offer

different output configurations for different loudspeaker setups, including Dual Channel mode, for passive setups, Mix TOP/SUB mode, in which two channels are driven through a single output connector, and 2-Way Active mode, which also sends the output of two channels down one connector to drive appropriate loudspeakers actively. The d&b switch functions provide selected filters to precisely tailor a wide variety of setups to their applications. Examples of these switch functions are the CSA (Cardioid Subwoofer Array)

and HFC (High Frequency Compensation) modes. CSA increases low frequency directivity control by minimising energy transmission towards the rear while HFC compensates for air absorption for loudspeakers covering far field listening positions. In addition to these functions, d&b amplifiers offer a comprehensive set of specific filters such as CUT, a cut mode for TOP loudspeakers when used with d&b subwoofers; CPL, to compensate for the coupling effect between loudspeakers in close proximity to other loudspeakers or hard objects and HFA

mode, to attenuate the high frequencies of a loudspeaker to mimic the effect of far field listening. These devices offer extended, user-definable equalization and delay capabilities, eliminating the need for external processing devices in the signal chain. All d&b amplifiers integrate with the d&b Remote network to enable the remote control and management of systems from anywhere within a network. Further information is provided in the d&b Amplifier and Software brochure which is available for download at [www.dbaudio.com](http://www.dbaudio.com).

## Comparison of the d&b amplifiers

	D80	30D	D20	10D	D6
<b>User interface</b>	Encoder/colour TFT touchscreen	LED indicators	Encoder/colour TFT touchscreen	LED indicators	Encoder/LC display
<b>Output channels</b>	4	4	4	4	2
<b>Input channels</b>	4 x AES3 or 4 x analog or 2 x AES3 and 2 x analog	4 x AES3 and 4 x analog	4 x AES3 or 4 x analog or 2 x AES3 and 2 x analog	4 x AES3 and 4 x analog	2 x AES3 or 2 x analog
<b>Latency</b>	0.3 msec	0.3 msec	0.3 msec	0.3 msec	0.3 msec
<b>User equalizers (per channel)</b>	2 x 16-band	2 x 16-band	2 x 16-band	2 x 16-band	4-band
<b>Delay</b>	10 sec/3440 m	10 sec/3440 m	10 sec/3440 m	10 sec/3440 m	340 msec/116.9 m
<b>Maximum output power (THD+N &lt; 0.5%, 12 dB crest factor)</b>	4 x 2000 W into 8 ohms 4 x 4000 W into 4 ohms	4 x 800 W into 8 ohms 4 x 1600 W into 4 ohms	4 x 800 W into 8 ohms 4 x 1600 W into 4 ohms	4 x 350 W into 8 ohms 4 x 700 W into 4 ohms	2 x 350 W into 8 ohms 2 x 600 W into 4 ohms
<b>Output routing</b>	Dual Channel, Mix TOP/SUB 2-Way Active	Dual Channel, Mix TOP/SUB 2-Way Active	Dual Channel, Mix TOP/SUB 2-Way Active	Dual Channel, Mix TOP/SUB 2-Way Active	Dual Channel
<b>Output connectors</b>	NL4/EP5 plus central NL8	Phoenix Euroblock	NL4 plus central NL8	Phoenix Euroblock	NL4
<b>GPIO connector, 5 ports</b>	No	Phoenix Euroblock	No	Phoenix Euroblock	No
<b>Cable compensation</b>	LoadMatch	LoadMatch	LoadMatch	LoadMatch	No
<b>Power supply</b>	Autosensing switched mode power supply with active PFC	Universal range switched mode power supply with active PFC	Universal range switched mode power supply with active PFC	Universal range switched mode power supply with active PFC	Autosensing switched mode power supply with active PFC
<b>Mains voltage</b>	100 - 127/208 - 240 V, 50 - 60 Hz	100 - 240 V, 50 - 60 Hz	100 - 240 V, 50 - 60 Hz	100 - 240 V, 50 - 60 Hz	100 - 120/220 - 240, 50 - 60 Hz
<b>Weight (kg/lb)</b>	19/42	10.6/23.4	10.8/23.8	10.6/23.4	8/17.6
<b>Dimensions</b>	2 RU x 19" x 530 mm	2 RU x 19" x 435 mm	2 RU x 19" x 460 mm	2 RU x 19" x 435 mm	2 RU x 19" x 353 mm
<b>Remote</b>	OCA via Ethernet/CAN	OCA via Ethernet/CAN	OCA via Ethernet/CAN	OCA via Ethernet/CAN	CAN
<b>Airflow</b>					



# The d&b amplifier controller setups and operation with d&b amplifiers

## Arc and Line setups

The Arc mode is intended for line array loudspeakers when used in curved array sections. The Line mode is used for long throw array sections with three or more consecutive splay settings of 0°, 1° or 2°. Compared to the Arc mode, the mid/high range is reduced to compensate for the extended near field.

## AP setup

In connection with ArrayProcessing (AP), the AP setup contains the AP data that are generated in the ArrayCalc simulation software. These are transferred to the applicable amplifiers via the d&b Remote network (OCA/AES70) using R1.

## CUT mode

Set to CUT, the cabinet low frequency level is reduced and is configured for use with d&b active subwoofers.

## HFC mode

Selecting the HFC (High Frequency Compensation) mode compensates for loss of high frequency energy due to absorption in air when loudspeakers are used to cover far field listening positions. HFC has two settings which should be used selectively, HFC1 for cabinets covering distances larger than 25 m (82 ft) and HFC2 for those covering distances larger than 50 m (164 ft). This can be used to achieve the correct sound balance between close and remote audience areas allowing all amplifiers driving the array to be fed from the same signal source.

## HFA mode

In HFA mode (High Frequency Attenuation), the HF response of the system is rolled off. The HFA provides a natural, balanced frequency response when a unit is placed close to listeners in near field or delay use. HFA begins gradually at 1 kHz, dropping by approximately 3 dB at 10 kHz. This roll off mimics the decline in frequency response experienced when listening to a system from a distance in a typically reverberant room or auditorium.

## CPL function

The CPL (Coupling) function compensates for coupling effects between the cabinets of an array. CPL begins gradually around 1 kHz, with the maximum attenuation below 100 Hz.

## 100 Hz mode

The 100 Hz mode limits the upper operating frequency of the subwoofer to 100 Hz, complementing top cabinets in full range mode.

## CSA mode

CSA (Cardioid Subwoofer Array) mode enables the combination of three or multiples of three B6-SUB cabinets within an array producing exceptional low frequency directivity control. The amplifier channel for the centre subwoofer of the column, which is physically pointed to the rear, has CSA selected. The forward facing cabinets are driven with an amplifier channel set in the standard mode. For further information please refer to the d&b TI 330 Cardioid Subwoofer Array, which is available for download at [www.dbaudio.com](http://www.dbaudio.com).

## Recommended amplifiers for mobile applications

	Y7P	Y10P	B6	Y8	Y12	Y-SUB
<b>D80</b>	x	x	x	x	x	x

## Recommended amplifiers for installation applications

	Yi7P	Yi10P	Bi6	Yi8	Yi12	Yi-SUB
<b>D80</b>	x	x	x	x	x	x
<b>30D</b>	x	x	x	x	x	x

## Maximum loudspeakers per amplifier channel

	Y7P Yi7P	Y10P Yi10P	B6 Bi6	Y8 Yi8	Y12 Yi12	Y-SUB Yi-SUB
	2	2	2	2	2	2

## Available controller settings

	Y7P Yi7P	Y10P Yi10P	B6 Bi6	Y8 Yi8	Y12 Yi12	Y-SUB Yi-SUB
<b>Arc/Line</b>				x	x	
<b>AP</b>				x	x	x
<b>CUT</b>	x	x		x	x	
<b>HFC</b>				x	x	
<b>HFA</b>	x	x				
<b>CPL</b>	x	x		x	x	
<b>100 Hz</b>			x			x
<b>CSA</b>			x			

# The Y-Series frequency responses

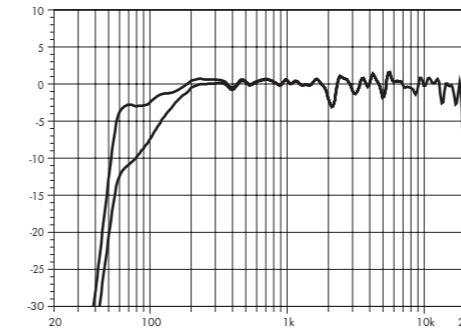

Y7P/Yi7P standard and CUT

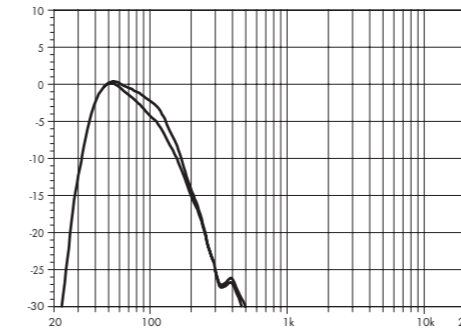

B6-SUB/Bi6-SUB standard and 100 Hz

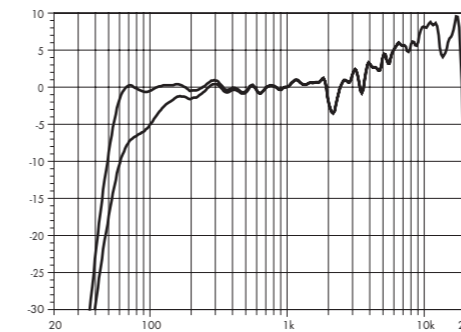

Y12/Yi12 standard and CUT (single cabinet)

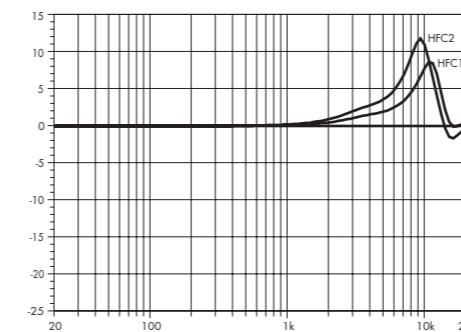

Correction of HFC\*  
\*schematic diagram

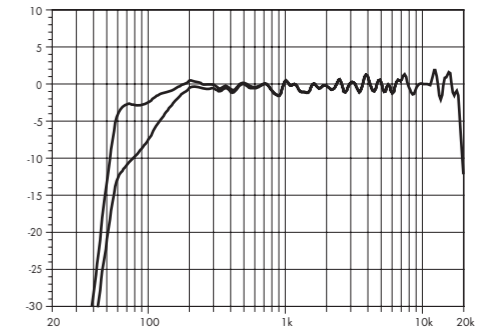

Y10P/Yi10P standard and CUT

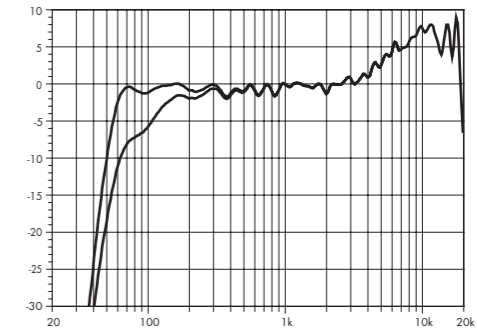

Y8/Yi8 standard and CUT (single cabinet)

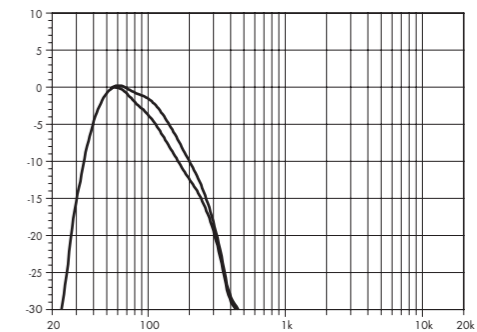

Y-SUB/Yi-SUB standard and 100 Hz

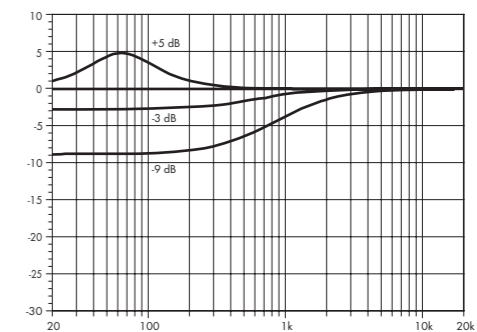

Correction of CPL\*  
\*schematic diagram

# The d&b amplifier output modes

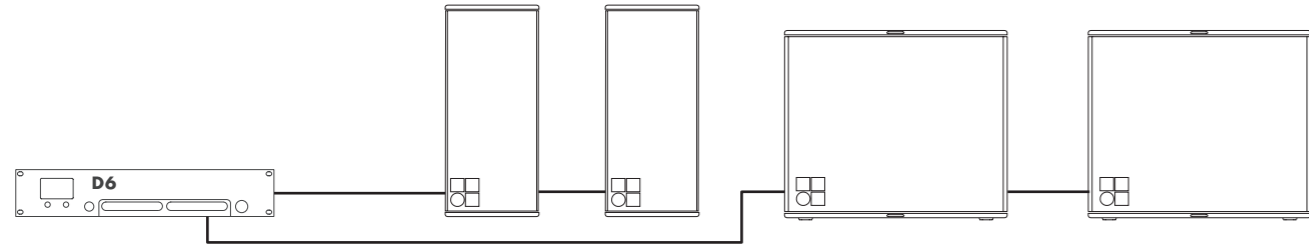

**D6 amplifier in Dual Channel mode for Y7P, Y10P, Yi7P, Yi10P, Y8, Y12, Yi8, Yi12 as well as B6-SUB, Bi6-SUB, Y-SUB and Yi-SUB**

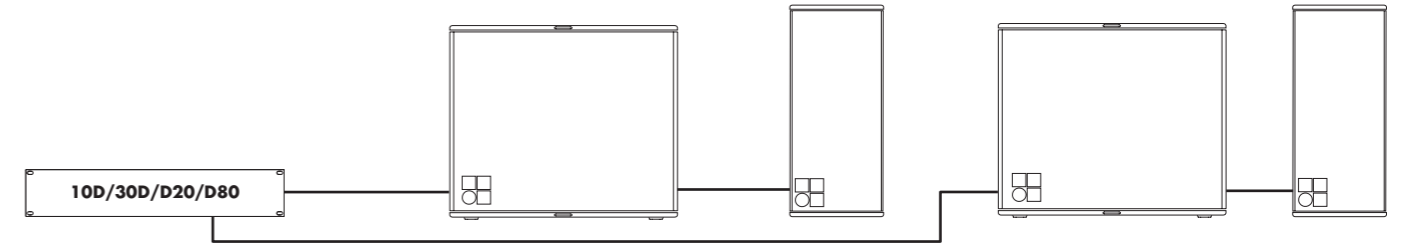

**10D/30D/D20/D80 amplifier in Mix TOP/SUB mode for Y7P, Y10P, Yi7P, Yi10P, Y8, Y12, Yi8 or Yi12 and B6-SUB, Bi6-SUB, Y-SUB or Yi-SUB**

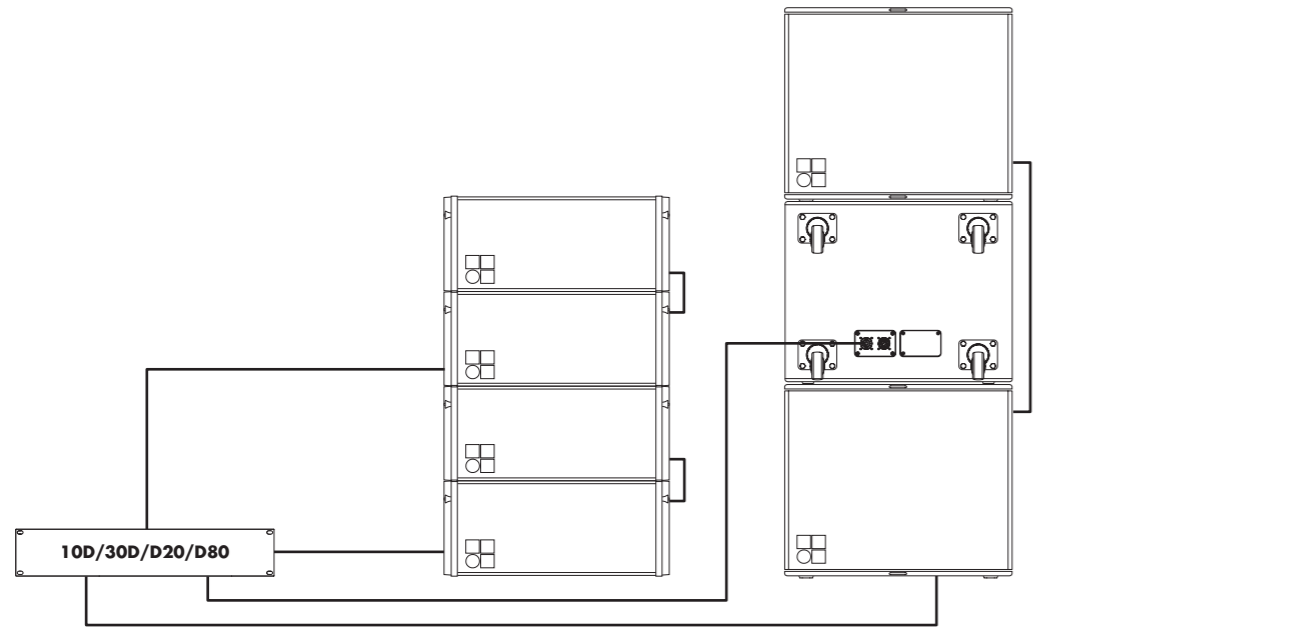

**10D/30D/D20/D80 amplifier in Dual Channel mode for Y7P, Y10P, Yi7P, Yi10P, Y8, Y12, Yi8, Yi12 as well as B6-SUB, Bi6-SUB, Y-SUB and Yi-SUB (B6-SUB as CSA)**

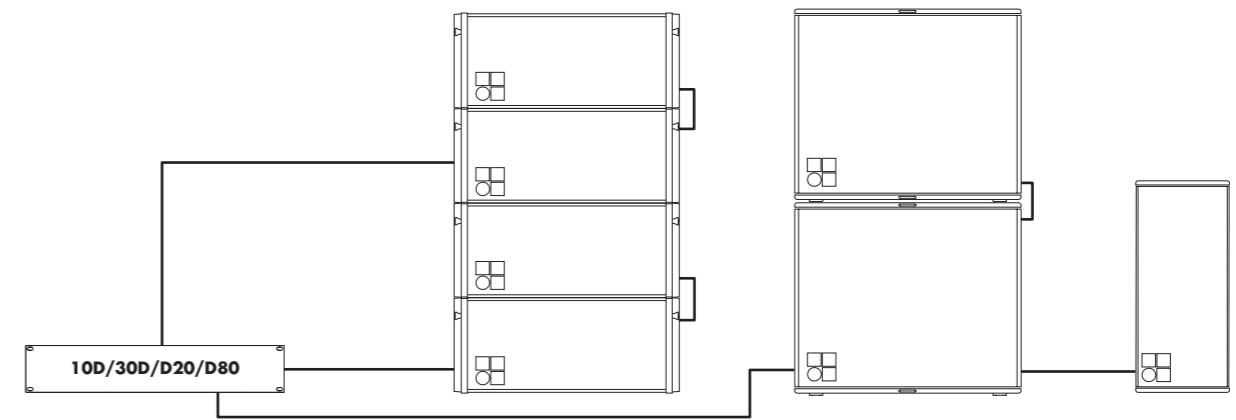

**10D/30D/D20/D80 amplifier in a mixed configuration of Dual Channel and Mix TOP/SUB mode for Y7P, Y10P, Yi7P, Yi10P, Y8, Y12, Yi8 or Yi12 and B6-SUB, Bi6-SUB, Y-SUB or Yi-SUB**

# The DS10 Audio network bridge

## The DS100 Signal Engine

### DS10 Audio network bridge

The DS10 Audio network bridge interfaces between Dante networks and AES3 digital audio signals, while also providing distribution of Ethernet control data. Positioned within the signal chain in front of the amplifiers, this 1 RU device expands the d&b system approach. Each unit can deliver up to sixteen Dante network channels via AES3 digital signal outputs. Additionally, four AES3 input channels provide access to the Dante audio network for applications such as a break-in from a Front of House console.

The DS10 incorporates an integrated 5-port switch, offering a primary and redundant network for the Dante protocol, as well as advanced functions such as Multicast Filtering and VLAN modes. Using the DS10 Audio network bridge, audio signals and remote control data can be combined using a single Ethernet cable.



The DS10 Audio network bridge front view



The DS10 Audio network bridge rear view

### DS100 Signal Engine

The d&b DS100 Signal Engine is the platform underneath the Soundscape, based on a specialized rack mount 3 RU audio processor with Audinate Dante networking. It provides a 64 x 64 audio matrix with level and delay adjustments at all cross points. Additional software modules provide dynamic source positioning and emulated acoustics functions.

The DS100 is a versatile tool for use within complex audio systems to route and distribute multiple audio channels to numerous amplifiers driving loudspeaker positions and zones, show relay and break out rooms. The networking capabilities with a Dante enabled processor are significant, particularly for busy, multi-room complexes.

The DS100 completely integrates with the overall d&b system approach, including loudspeakers, amplifiers, rigging, transport and networking accessories and the DS10 Audio network bridge. The complete system is designed and optimized in the d&b ArrayCalc simulation software, and controlled via the d&b R1 Remote control software.

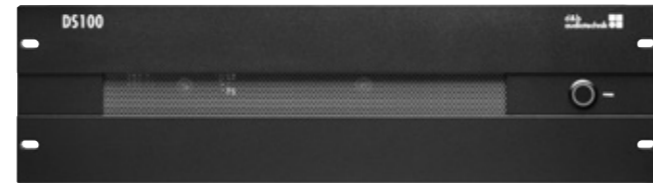

The DS100 Signal Engine front view

# The Y-Series configuration examples

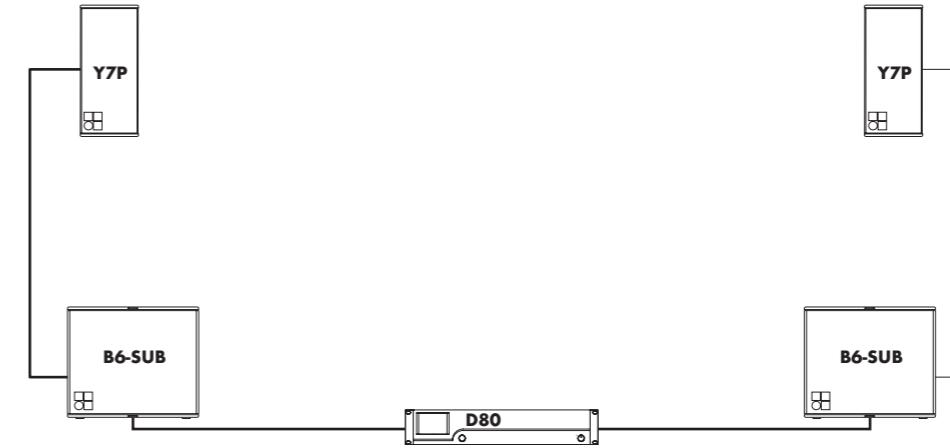

Y-Series L/R configuration comprising Y7P and B6-SUB with a D80 amplifier in Mix TOP/SUB mode<sup>1</sup>

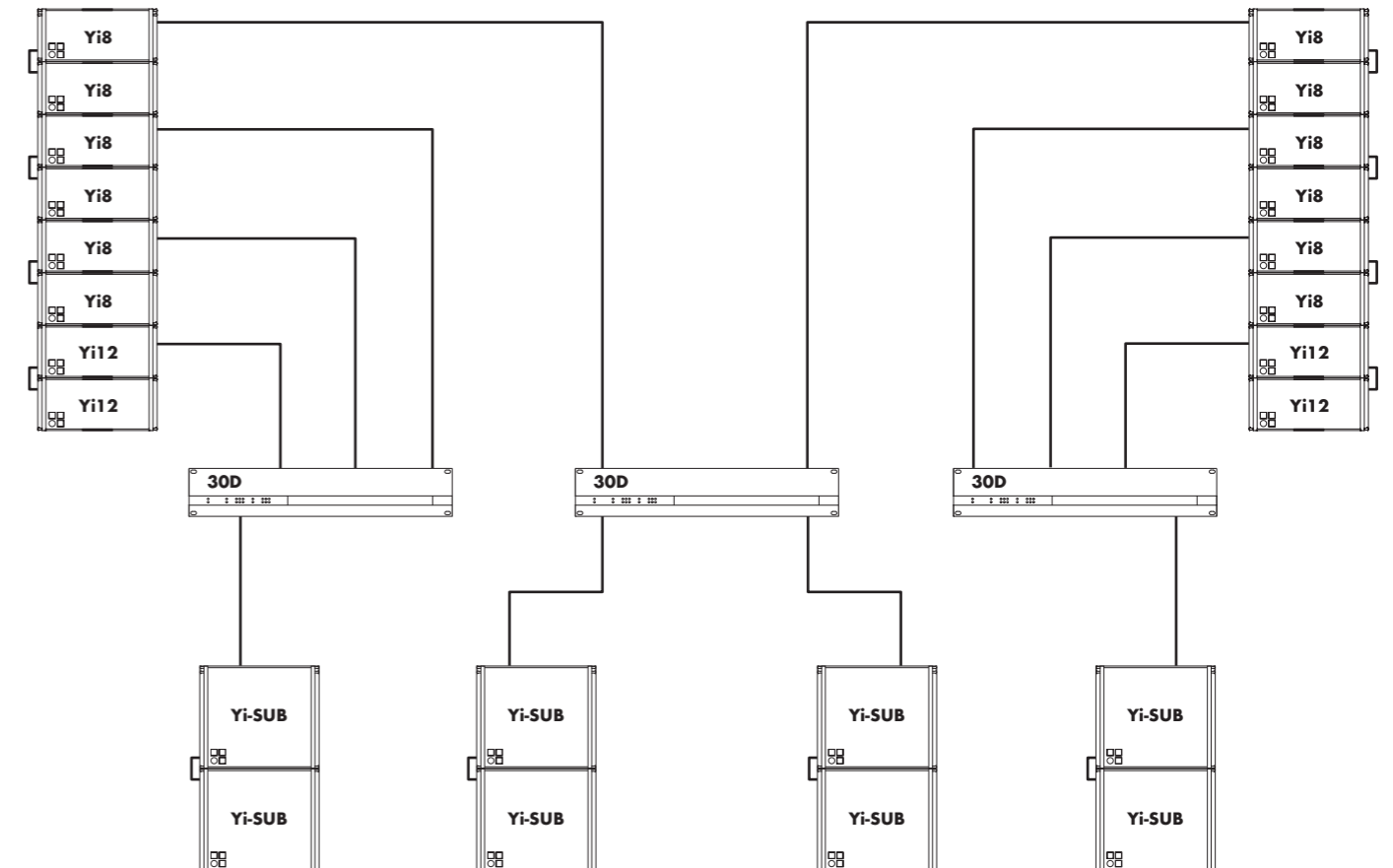

Yi line array in L/R configuration with flown Yi8/Yi12s and ground stacked Yi-SUBs with 30D amplifiers in Dual Channel mode<sup>1</sup>

# The Y-Series configuration examples

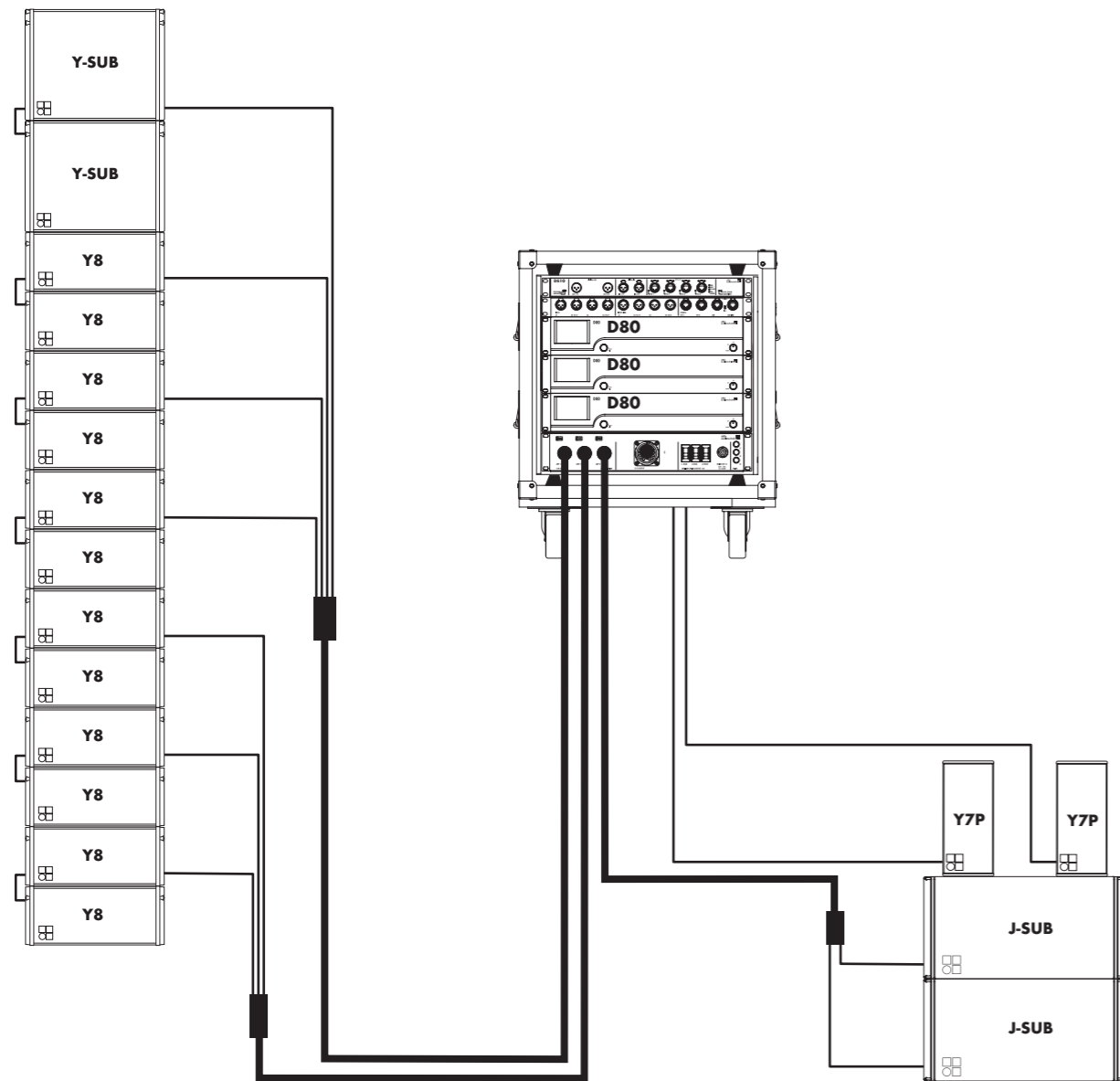

Y-Series configuration comprising Y8 and Y-SUB flown array with ground stacked J-Subs and Y7P as nearfill with D80 Touring rack<sup>1</sup>

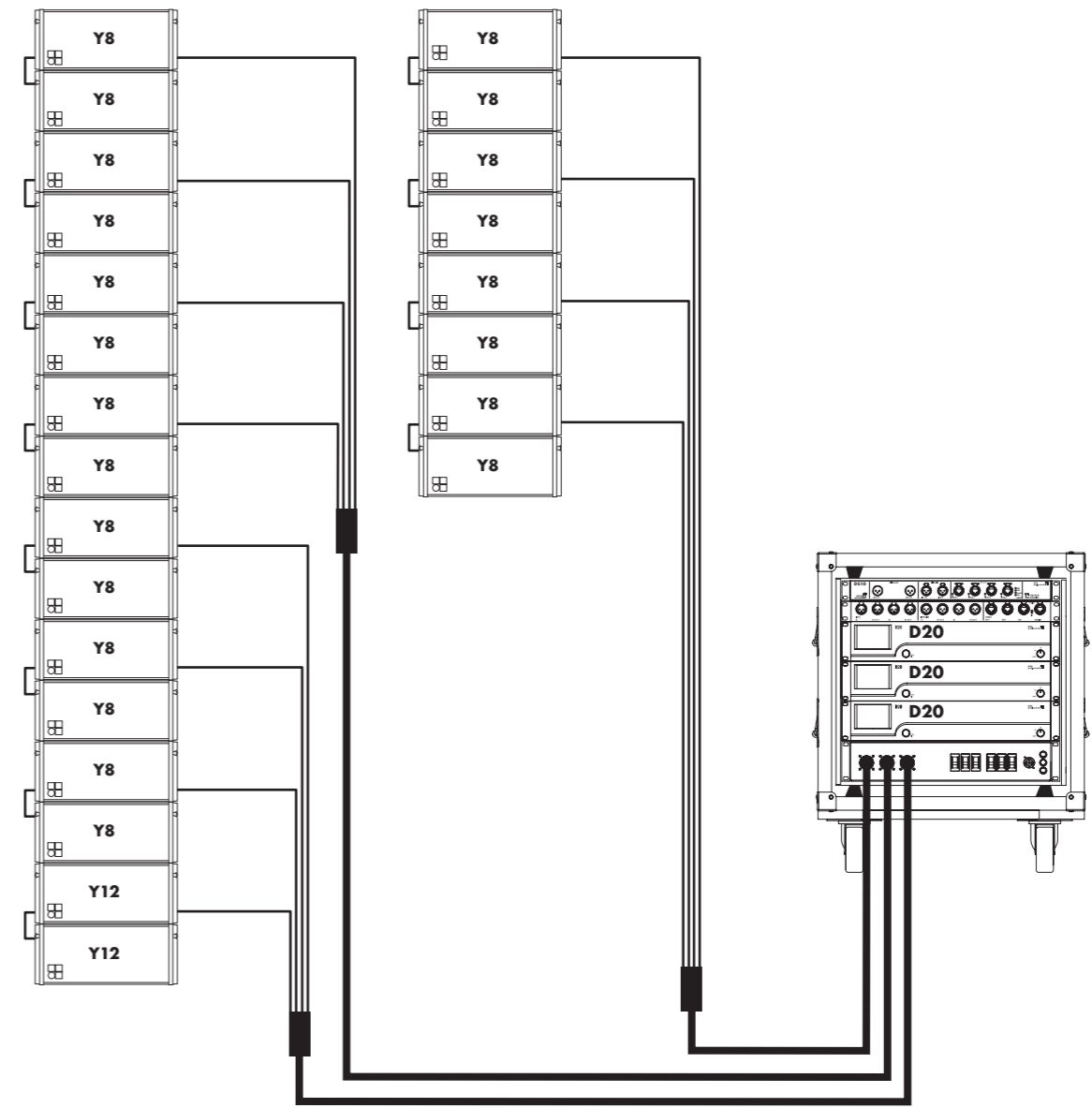

Y-Series configuration comprising Y8/Y12 mains and Y8 outfill arrays with D20 Touring rack<sup>1</sup>

# The Y-Series configuration examples with ArrayProcessing

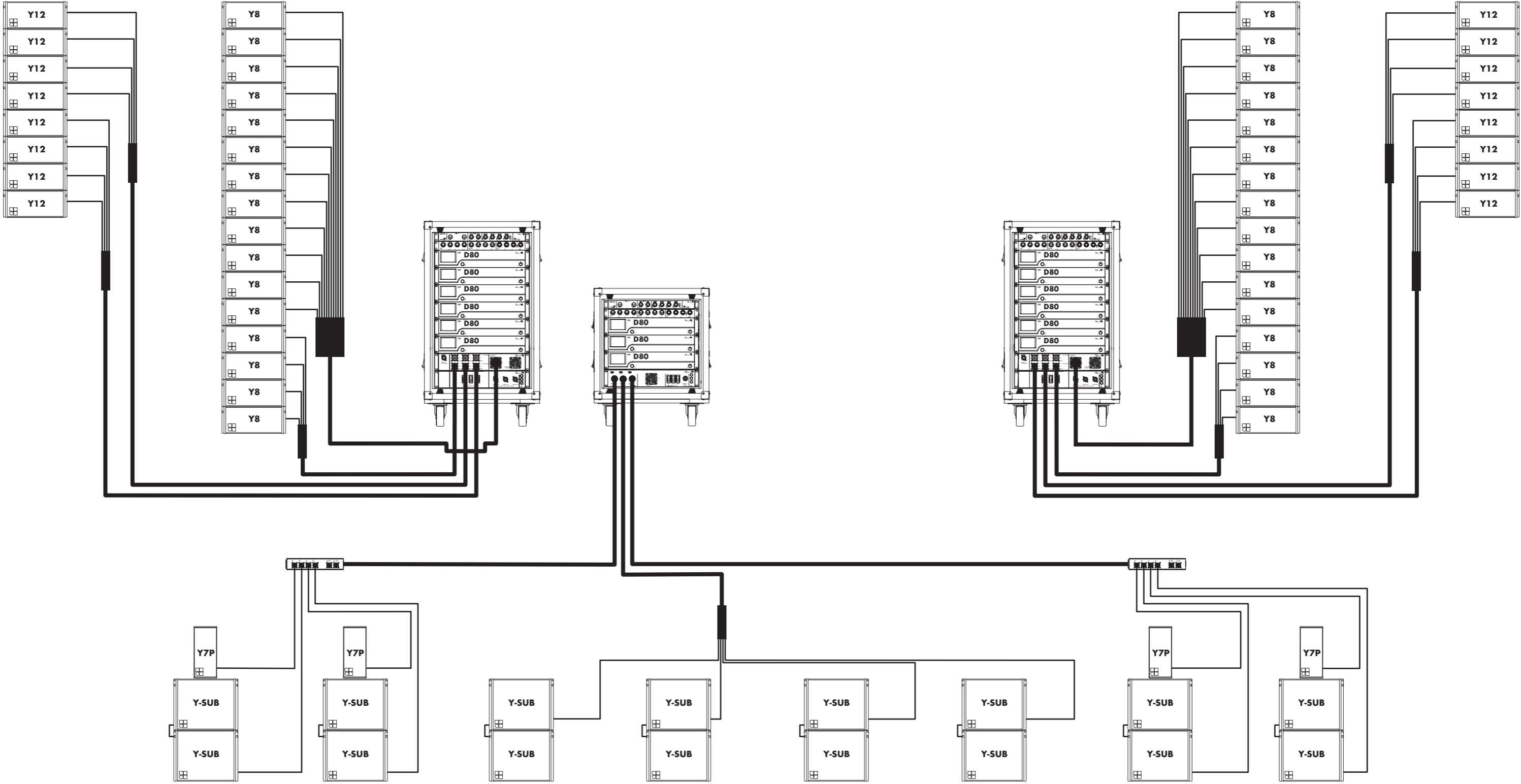

Y-Series configuration comprising Y8 mains and Y12 outfill arrays driven with ArrayProcessing along with ground stacked Y-SUBs and Y7P as nearfills with D80 Touring racks<sup>1</sup>

<sup>1</sup> These configurations are also valid for Yi loudspeakers

# The Y-Series cables and adapters MC8 / MC24

## Amplifiers in Dual Channel mode

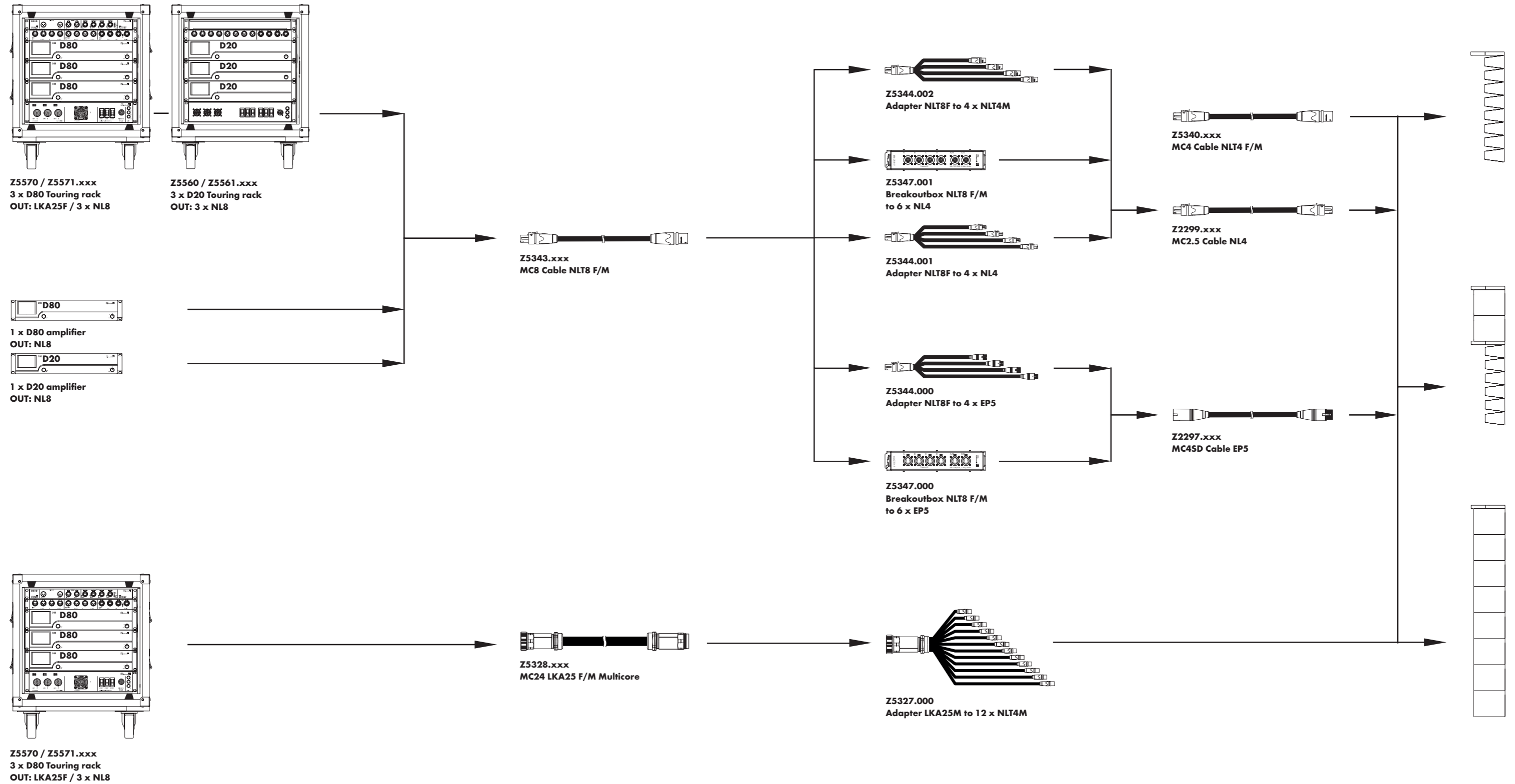

# The Y-Series cables and adapters MC8 / MC24

## Amplifiers in Dual Channel mode

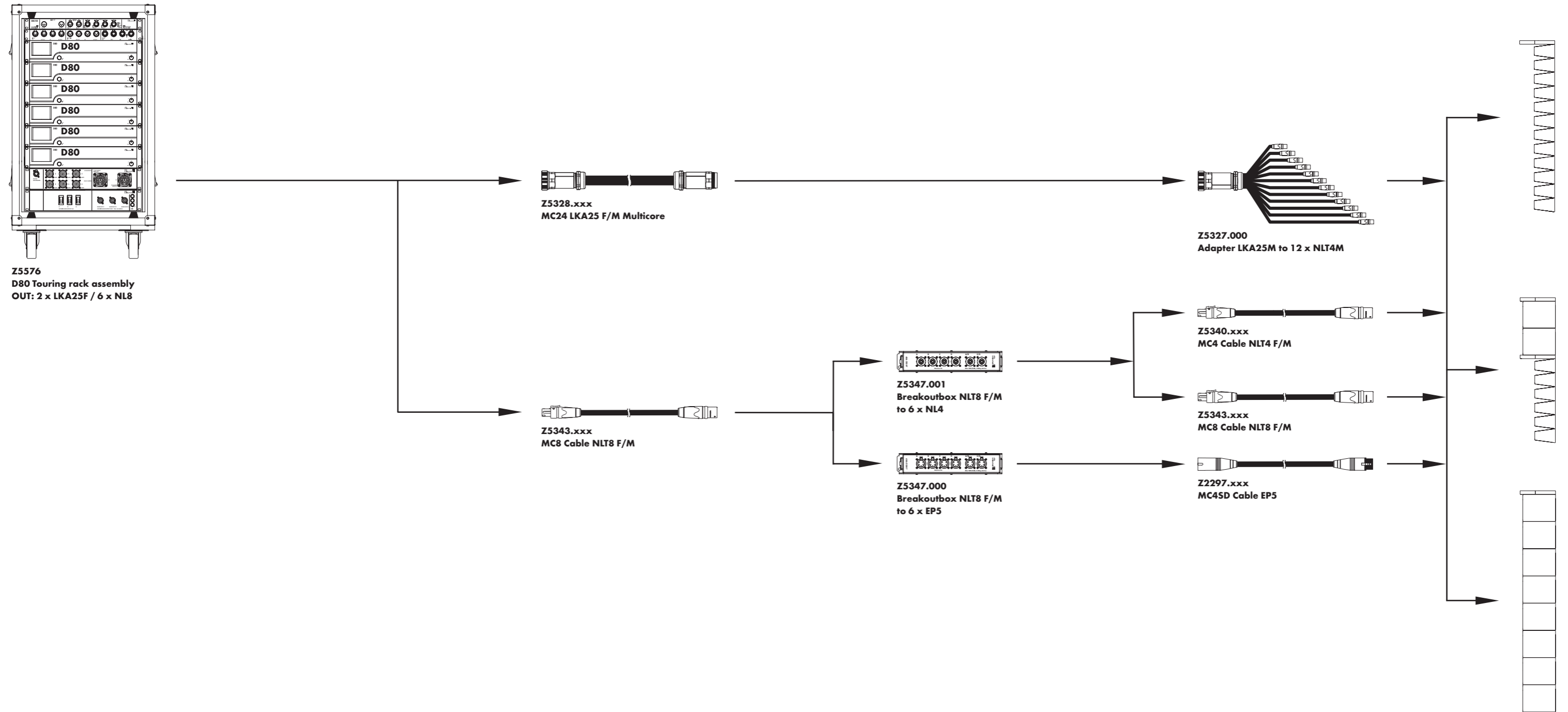

# The Y-Series product overview

<b>Y loudspeakers</b>	Z0702.xxx Z0703.xxx Z0710.xxx Z0707.xxx Z0708.xxx Z0709.xxx	<b>Y7P loudspeaker</b> <b>Y10P loudspeaker</b> <b>B6 subwoofer</b> <b>Y8 loudspeaker</b> <b>Y12 loudspeaker</b> <b>Y subwoofer</b>	<b>Remote network</b>	Z6118.000 Z6124.000	<b>R60 USB to CAN interface</b> <b>R70 Ethernet to CAN interface</b>
<b>Loudspeaker connector options</b>	Zxxxx.002 Zxxxx.000 Zxxxx.001	<b>NLT4 F/M</b> connector <b>EP5</b> connector <b>NL4</b> connector	<b>Amplifiers</b>	Z2710.xxx Z2750.xxx Z2770.xxx Z2760.xxx Z2700.xxx	<b>D80 amplifier</b> <sup>4</sup> <b>D20 amplifier</b> <sup>4</sup> <b>30D amplifier</b> <sup>5</sup> <b>10D amplifier</b> <sup>5</sup> <b>D6 amplifier</b> <sup>5</sup>
<b>Yi loudspeakers</b>	Z0712.001 Z0713.001 Z0711.001 Z0717.001 Z0718.001 Z0719.001	<b>Yi7P loudspeaker NL4</b> connector <b>Yi10P loudspeaker NL4</b> connector <b>Bi6 subwoofer NL4</b> connector <b>Yi8 loudspeaker NL4</b> connector <b>Yi12 loudspeaker NL4</b> connector <b>Yi subwoofer NL4</b> connector  <b>WR Weather Resistant option</b> <sup>1</sup> <b>SC Special Colour option</b> <sup>2</sup>	<b>Processing and distribution</b>	Z4010.000 Z4100.000	<b>DS10 Audio network bridge</b> <b>DS100 Signal Engine</b>
<b>Loudspeaker cases</b>	E7473.000 E7472.000 E7475.000	<b>Touring case 2 x Y7P/Y10P</b> <b>Touring case 4 x Y8/Y12</b> <b>Touring case 2 x Y Flying frame</b>	<b>Amplifier rack assemblies</b>	Z5560.xxx Z5561.xxx Z5330.xxx Z5562.xxx Z5570.xxx Z5571.xxx Z5576.xxx	<b>3 x D20 Touring rack</b> <sup>6</sup> <b>3 x D20 Touring rack</b> (includes DS10) <sup>6</sup> <b>D80 Touring rack</b> <sup>6</sup> <b>D80 Touring rack</b> (includes DS10) <sup>6</sup> <b>3 x D80 Touring rack</b> <sup>6</sup> <b>3 x D80 Touring rack</b> (includes DS10) <sup>6</sup> <b>6 x D80 Touring rack</b> (includes DS10) <sup>6</sup>
<b>Loudspeaker carts</b>	E7470.000 E7471.000	<b>Touring cart 4 x Y8/Y12</b> <b>Touring cart 8 x Y8/Y12</b>	<b>Racks</b>	E7480.000 E7468.000 E7483.000	<b>D20 Touring rack 2 RU, 19"</b> SD, shock mounted, handles <b>D80 Touring rack 2 RU, 19"</b> SD, shock mounted, handles <b>DS100 Touring rack 3 RU, 19"</b> SD, shock mounted, handles
<b>Lids</b>	E7925.000 E7924.000	<b>B6-SUB Transport lid</b> <b>Y-SUB Transport lid</b>	<b>Cables and adapters</b>	Z5339.000 Z5343.xxx Z5345.001 Z5344.002 Z5344.001 Z5344.000 Z5347.001 Z5347.000 Z5340.xxx Z5328.xxx Z5327.000	<b>Multichannel extension cable</b> <b>MC8 Cable NLT8 F/M</b> <b>Adapter 4 x NL4 to NLT8M</b> <b>Adapter NLT8F to 4 x NLT4M</b> <b>Adapter NLT8F to 4 x NL4</b> <b>Adapter NLT8F to 4 x EP5</b> <b>Breakoutbox NLT8 F/M to 6 x NL4</b> <b>Breakoutbox NLT8 F/M to 6 x EP5</b> <b>MC4 Cable NLT4 F/M</b> <b>MC24 LKA 25 F/M Multicore</b> <b>Adapter LKA25M to 12 x NLT4M</b>
<b>YP accessories</b>	Z5397.000 Z5398.000 Z5399.000 Z5389.000 Z5010.000 Z5012.500 Z5049.000 Z5013.000 Z5009.000 Z5024.000	<b>YP Swivel bracket</b> <b>YP Horizontal bracket</b> <sup>3</sup> <b>YP Mounting bracket</b> <sup>3</sup> <b>Bi6-SUB Horizontal bracket</b> <sup>3</sup> <b>TV Spigot with fixing plate</b> <b>Pipe clamp</b> for TV Spigot <b>Flying pin 8mm</b> <b>Loudspeaker stand winder M20</b> <b>Loudspeaker stand with winder</b> <b>Loudspeaker stand adapter</b>			
<b>Y accessories</b>	Z5390.000 Z5394.000 Z5393.000 Z5393.001 Z5396.000 Z5391.000 Z5392.000 Z5147.001 E6507.000	<b>Y Flying frame</b> <sup>3</sup> <b>Y Flying adapter</b> <sup>3</sup> <b>Y Mounting frame top</b> <sup>3</sup> <b>Y Mounting frame bottom</b> <sup>3</sup> <b>Y Base plate</b> <b>Y Hoist connector chain</b> <b>Y Safety chainset</b> <b>Rota clamp</b> <b>1t Shackle</b>			

<sup>1</sup> WR only for Yi loudspeakers, on request

<sup>2</sup> SC only for Yi loudspeakers, on request

<sup>3</sup> SC on request

<sup>4</sup> The complete list of mobile amplifier versions is available in the D Amplifier and Software ww

<sup>5</sup> The complete list of installation amplifier versions is available in the xD Installation Amplifier and Software brochure

<sup>6</sup> Further information is available in the D Amplifier and Software brochure



