

xD

Installation
Amplifiers
Software



Contents



- The d&b System reality** 6
- The d&b Workflow** 6
- The d&b ArrayCalc simulation software** 8
- The d&b Remote network** 10
- The d&b Remote network topology** 12
- The DS10 Audio network bridge** 13
- The DS100 Signal Engine** 13
- The 10D/30D amplifiers** 14
- The 10D amplifier** 18
- The 30D amplifier** 20
- Installation amplifiers and software product overview** 22

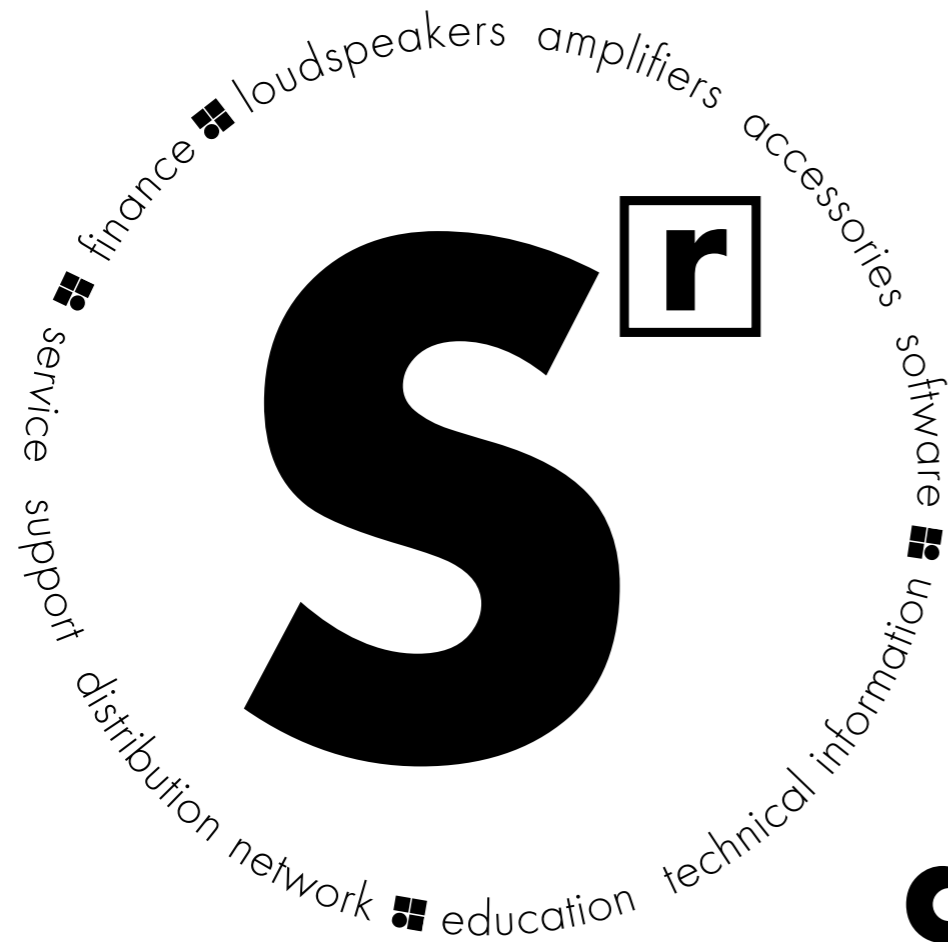

d&b System reality

As the name implies a d&b audiotechnik system is not just a loudspeaker. Nor is it merely a sum of the components: loudspeakers, amplifiers, signal processors, networking, software and accessories. Right from the outset the d&b audiotechnik approach was to build integrated sound reinforcement systems

that actually are more than the combination of parts: an entirety where each fits all. Every element is tightly specified, precisely aligned and carefully matched to achieve maximum efficiency. For ease of use, all the user-definable parameters are incorporated, allowing the possibility of adjustment, either

directly, via remote control surfaces, or integrated within wider networks. Neutral sound characteristics leave the user all the freedom needed to realize whatever the brief. At the same time d&b offers finance, service and support, a knowledgeable distribution network, education and training as well as technical

information, so the same optimal acoustic result is achieved consistently by every system anywhere, at any time. In reality: the d&b System reality.

The d&b Workflow

Planning and simulation

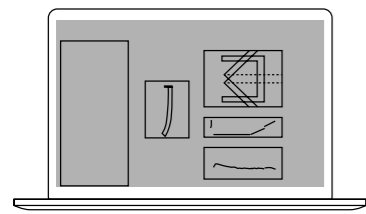

d&b ArrayCalc simulation software

Control and operation

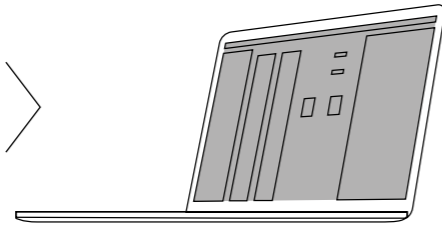

d&b R1 Remote control software

Processing and distribution

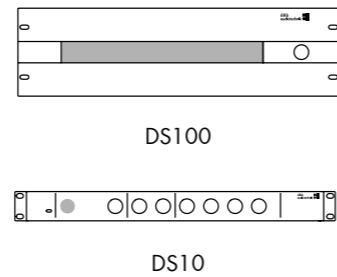

d&b network audio devices

Amplification

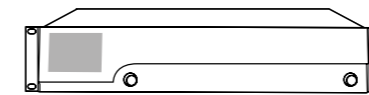

d&b amplifiers

Reproduction

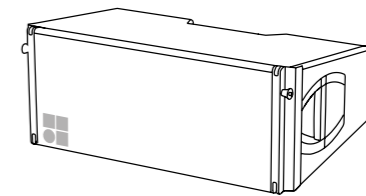

d&b loudspeakers

The integrated **d&b Workflow** improves efficiency all the way from the start of a project through planning and simulation to control of the final result. Venue data is used to create a model in the d&b ArrayCalc simulation software. The choice of the loudspeakers, placement, levels and configuration is also entered

into this room model. The effect of the scheme can be simulated, carefully checked and optimised, until the desired performance is achieved. When the mechanical array settings have been finalized, the optional ArrayProcessing function within ArrayCalc applies powerful filter algorithms to optimize the level and tonal

balance of a line array over the entire audience area. ArrayCalc then generates rigging plans and parts lists for the final proposal. Once ready, the complete system configuration can be opened in the R1 Remote control software. A graphical user interface is generated automatically for the complete system and applies

all the defined settings to the amplifiers. The R1 Remote control software is used to make adjustments and monitor the system in as much detail as needed to ensure the sound is in line with the original intention.

The d&b ArrayCalc simulation software

The d&b ArrayCalc simulation software is the prediction tool for d&b systems. This is a comprehensive toolbox for all tasks associated with acoustic design, performance prediction, alignment, rigging and safety parameters. For safety reasons d&b line arrays must be designed using the d&b ArrayCalc simulation software. d&b ArrayCalc is available as a native stand-alone application for both Microsoft Windows (Win7 or higher) and Mac OS X2 (10.7 or higher) operating systems and is available at www.dbaudio.com, along with further information and video tutorials.

Simulation

Listening planes can be defined in the venue tab, creating a three dimensional representation of any audience area in a given venue. Special functions assist in obtaining accurate dimensions with laser distance finders and inclinometers. Flown arrays or subwoofer columns can be defined in a project file as single hangs or in pairs. Point source loudspeakers can also be fully integrated as well as a ground stacked SUB arrays. Level over distance is calculated for each source with high resolution in real time, for either band limited or broadband input signals. The comprehensive simulation precisely models the actual performance of the system, taking into account input level, all system configuration options (such as CUT, CPL, HFC or INFRA), limiter headroom and air absorption. Acoustic obstacles, such as video screens, can be added to a model. Acoustic shadowing, whether by these obstacles, or a balcony overhang, is taken into consideration. The load status of all array rigging components is calculated accurately and displayed to determine whether a given array is within the load tolerance. Subwoofer array design is assisted by coverage and polar plot prediction. A specialized algorithm allows the user to specify subwoofer positions and a coverage angle, which is then converted into appropriate delay settings that result in the desired dispersion. The alignment tab enables different sources to be time aligned to one another, as well as showing arrival times and Sound Pressure Levels at a definable reference point on one of the audience areas. For alignment of the flown system with the ground stacked SUB array, the phase response of both the SUB array and a flown source is calculated at a definable reference point. The level distribution resulting from the interaction of all active sources can be mapped onto the audience areas in a three-dimensional view. EASE and DXF data export capabilities are also available.

System setup

A rigging plot with all necessary coordinates, dimensions and weights of arrays is generated for export and printing and a parts list, detailing all components required. The d&b ArrayCalc Viewer app presents this key information for positioning and

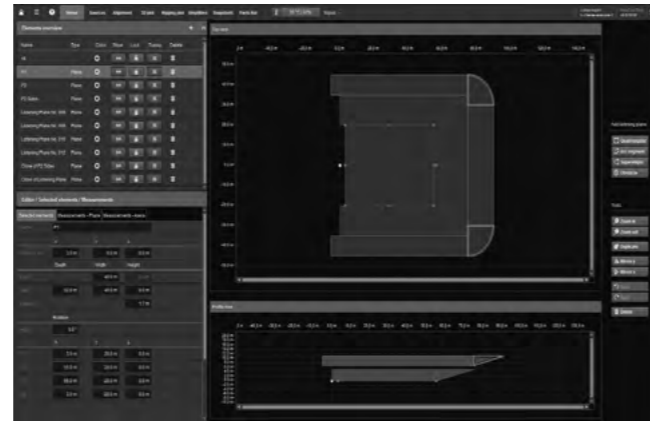

Venue

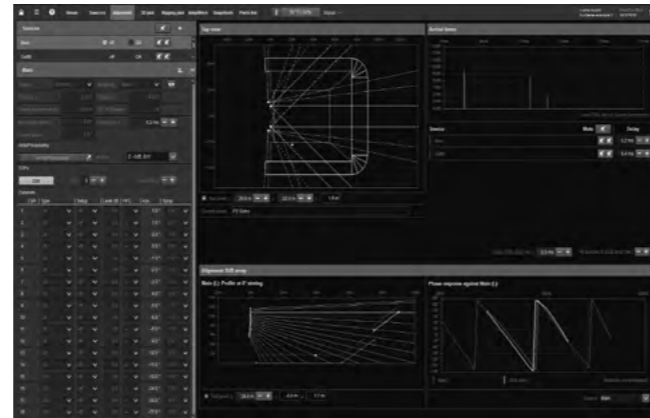

Alignment

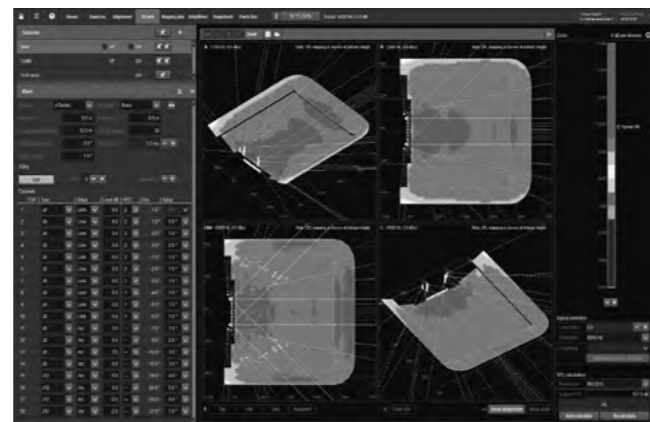

3D Plot quad

flying a d&b audiotechnik loudspeaker system on a mobile device. Once the system has been designed, calculated and optimized, the project files can be shared via email, AirDrop, or downloaded onto any iOS or Android device.

ArrayProcessing

The optional ArrayProcessing function applies powerful filter algorithms to optimize the tonal (spectral) and level (spatial) performance of a line array column over the audience area defined by its mechanical vertical coverage angle. Within the d&b ArrayCalc simulation software, spectral and level performance targets over the listening areas can be defined while specific level drops or offsets can be applied to certain areas, to assign reduced level zones. ArrayProcessing applies a combination of FIR and IIR filters to each individual cabinet in an array to achieve the targeted performance, with an additional latency of only 5.9 ms. This significantly improves the linearity of the response over distance as well as seamlessly correcting for air absorption. In addition, ArrayProcessing employs the same frequency response targets for all d&b line arrays, to ensure all systems share a common tonality. This provides consistent sonic results regardless of array length or splay settings. The resulting coverage is enhanced with spectral consistency and defined level distribution, achieving more linear dispersion and total system directivity to cover longer distances or steep listening areas effectively.

d&b Soundscape

The d&b ArrayCalc Software is also used for planning and simulation of d&b Soundscape. An Early reflections area can be defined in the Venue view, for which the En-Space software will calculate additional convolutions to better represent the early reflections of the original venue. Additionally Positioning areas can also be defined for use in combination with the En-Space software, which are used as a reference plane for positioning Sound objects either from R1 or via external controllers. The d&b Soundscape loudspeaker system is also planned, configured and simulated in ArrayCalc, with loudspeakers assigned to Function groups, for which the Soundscape algorithms calculate individual transfer functions according to their function within the system. DS100 Signal Engine devices can be added to a project, together with the necessary DS10 Audio network bridges. Signal routing can be defined for the whole signal path, from DS100 to loudspeaker, through the DS10 and amplifier devices. A Dante Controller preset file can be automatically generated in ArrayCalc, including the complete Dante routing for the whole system. This preset file can be later loaded in Dante Controller, so that no manual Dante patching is required.

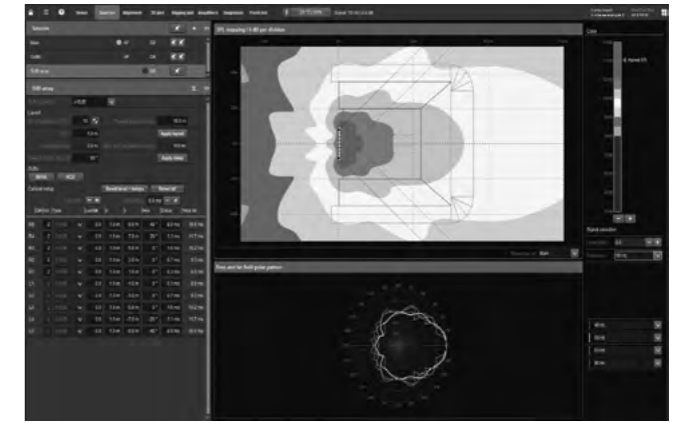

Sources, SUB array

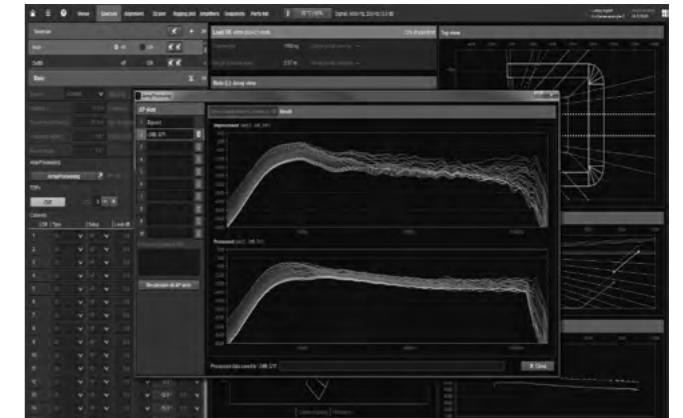

ArrayProcessing

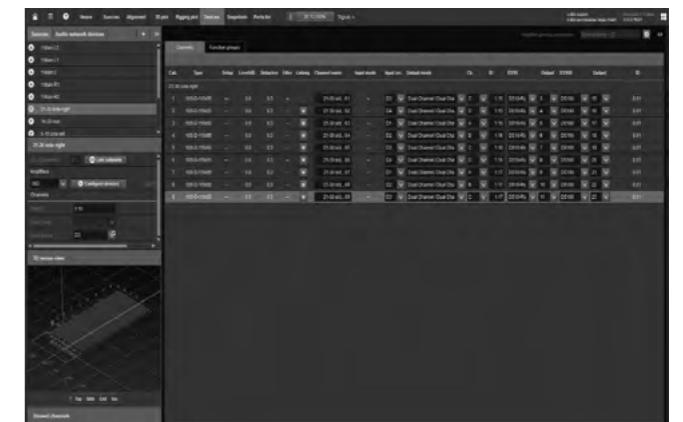

Devices

¹ Microsoft Windows is a registered trademark or trademark of Microsoft Corporation in the United States and/or other countries
² Mac OS X is a trademark of Apple Inc., registered in the U.S. and other countries

The d&b Remote network

The remote control capability of the d&b Remote network enables central control and monitoring of a complete d&b loudspeaker system from anywhere in the network, be it from a laptop in the control room, at the mix position, or on a wireless tablet computer in the auditorium. In the typical user workflow, the d&b Remote network takes settings optimized in the ArrayCalc simulation software and applies these to all the d&b devices within the network. In mobile situations R1 Remote control software provides extensive functionalities for storing and recalling system settings, enabling setups to be repeated as and when required. Project files can be adjusted for use with different equipment at another location. d&b System check verifies that the system performs within a predefined condition, while the Array verification function automatically identifies the physical position of a loudspeaker in an array to check that the system is cabled correctly. For permanent installations, system integrators can configure the d&b Remote network to allow access to different levels of control, according to the operational needs of the venue, with password protection available to restrict access to advanced functions if necessary. R1 enables d&b devices to be remotely controlled, using both Ethernet (AES70/OCA) and CAN-Bus in parallel. The software runs on both Microsoft Windows¹ (Win7 or higher) and Mac OS X² (10.7 or higher) operating systems and is available at www.dbaudio.com, along with further information and video tutorials.

R1 Remote control software

The R1 Remote control software uses the same project file created in ArrayCalc to automatically generate an intuitive graphical user interface including complete details of the simulated system. This user interface can be customized by the user, in order to fit particular user needs. Changes to the project file can be performed at any time in both ArrayCalc and R1. This workflow removes the need to manually transfer data from one software program to the other. All features, functions and controls from d&b devices can be remotely controlled and/or monitored using R1 Remote control software. It allows each channel of the amplifiers or the DS100 Signal Engine matrix to be controlled and enables the creation of groups of channels. When grouped together, a button or fader can control the overall system level, zone level, equalization and delay, system power ON/OFF, MUTE as well as loudspeaker specific function switches, such as CUT/HFA/HFC, CPL and ArrayProcessing. An offline mode is provided for preparation in advance of an event, without the need for physical devices being present or connected. The Home view provides an overview of all views in R1 and access to all user defined remote views. Each user definable Remote view can be populated with control



Home



Remote in Configuration mode

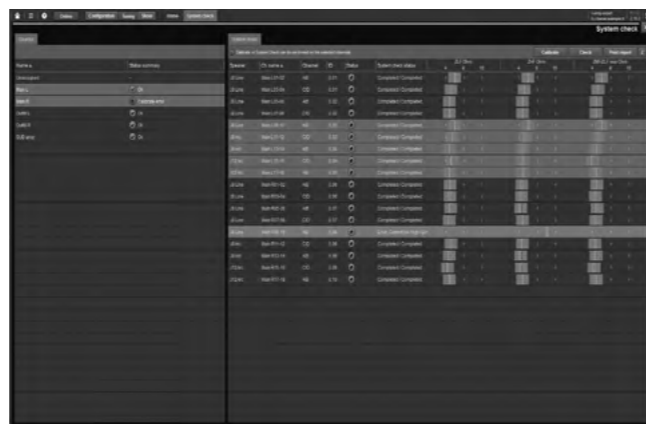

System check

functions of the system and can be optimized for different screen resolutions, either for large monitors or for smaller tablet devices.

DS10 Meta data

The DS10 Audio network bridge sends Meta data to the d&b amplifiers via the AES3 channel streams. This information can be read remotely from R1, and includes Dante channel subscription information, such as Dante labels and network and redundancy status. Additionally, cabling information is also provided, which makes it possible to find possible cabling mistakes in the audio signal chain.

d&b Soundscape

After system planning and simulation in ArrayCalc, the d&b Soundscape is completely configured, monitored and controlled in R1. The DS100 Signal Engine matrix can be operated manually by the controls on the Device view tabs or, alternatively, by controls in a Remote view. The Matrix crosspoint control provides an array of level and delay controls for a user defined range of matrix crosspoints. Input and Output processing is also available, with a combination of Polarity, Level and Delay available on all inputs and outputs. Additionally, an 8-band parametric EQ is provided on all inputs, and a 16-band parametric EQ on all outputs. Special Positioning remote views can be created for En-Space systems, in which Sound objects can be individually placed within the venue. En-Space sampled spaces can be selected within R1 from the available library provided with the En-Space software license. En-Space levels for inputs and outputs can also be controlled within the Device or Remote views, and additional EQ for each of the four zones of the space is provided.

Service functions

R1 enables the simultaneous firmware update of multiple devices from a central location. The software will automatically search the d&b website and on demand, downloads the latest available firmware versions and R1 Remote control software updates. Defined settings can be created, saved on a computer and loaded into the devices, for example to ensure that configuration switches are set to a known status, or the user definable equalization is set flat. Settings can be copied to additional or spare devices. For service purposes, information may be read from a device, concerning its condition during operation and errors reported. When additional support is required, the error report can be saved and sent to the d&b service departments for further assessment and diagnosis.

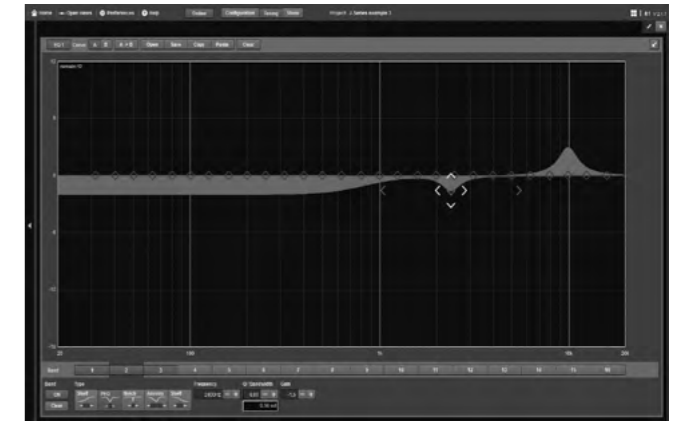

D20/D80 16-band equalizer



Positioning view

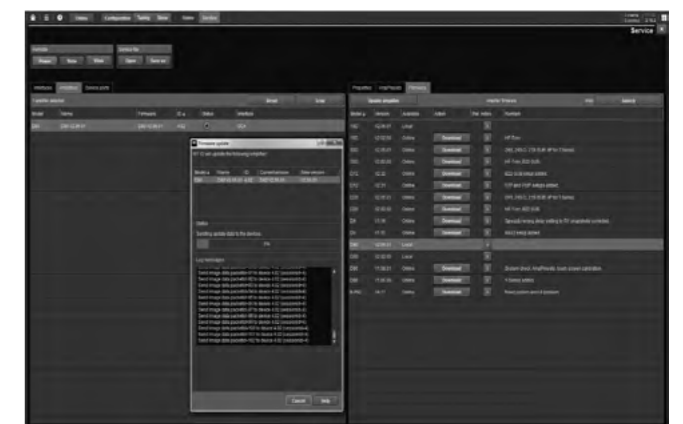

Service, Firmware update

¹ Microsoft Windows is a registered trademark or trademark of Microsoft Corporation in the United States and/or other countries
² Mac OS X is a trademark of Apple Inc., registered in the U.S. and other countries

The d&b Remote network topology

The 10D amplifier and 30D amplifier can be remote controlled using the industry standard OCA protocol via Ethernet and through the established CAN-Bus. These devices can be combined with other d&b amplifiers within the Remote network; the 10D, 30D, D20 and D80 amplifiers offer both OCA and CAN-Bus protocols whereas the D6 is only accessible using CAN-Bus. d&b amplifiers are controlled using the d&b R1 Remote control software, which is available on both Windows and MAC operating systems. This remote user interface can control the 10D, 30D, D20 and D80 amplifiers via Ethernet (OCA) and the D6 amplifier through CAN-Bus networks simultaneously. Additionally, the 10D, 30D, D20 and D80 amplifiers can also be controlled via a browser window with the integrated web interface.

d&b Remote network – OCA via Ethernet

The 10D, 30D, D20 and D80 amplifiers can be remotely controlled via a standard Ethernet network, providing higher bandwidth and quicker response compared to the CAN-Bus network. This latest generation of d&b amplifiers are all fitted with a dual Ethernet port, allowing simple networks to be set up without requiring an extra switch. The industry standard Open Control Architecture (OCA) protocol is used, created by the OCA Alliance of which d&b is a founding member. For further information please refer to the d&b TI 310 Ethernet networking, which is available for download at www.dbaudio.com.

d&b Remote network – CAN-Bus

The d&b amplifiers can be integrated within the CAN-Bus network and are fitted with two REMOTE/CAN connectors (RJ 45) to link the CAN-Bus signal and enable daisy chaining. The network may contain any combination of up to a total of 504 devices. It is connected to a PC or MAC running R1 Remote control software V2, using R60 USB to CAN, or R70 Ethernet to CAN interfaces. While the CAN-Bus network covers distances up to 600 m the Ethernet connection to the R70 can be made using standard Ethernet technologies, including wireless or fibre optic networks. For further information please refer to the TI 312 d&b Remote network, which is available for download at www.dbaudio.com.

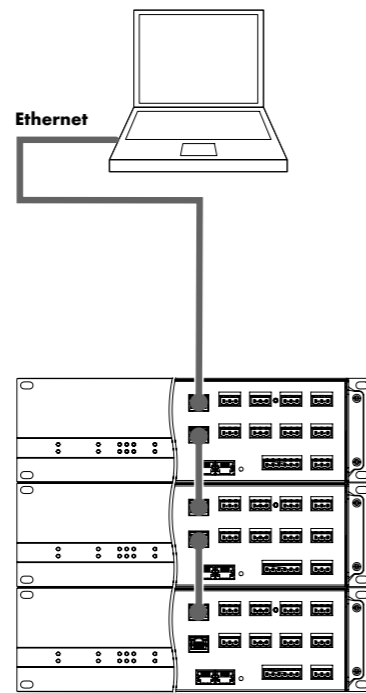

Daisy chain topology for maximum of three devices

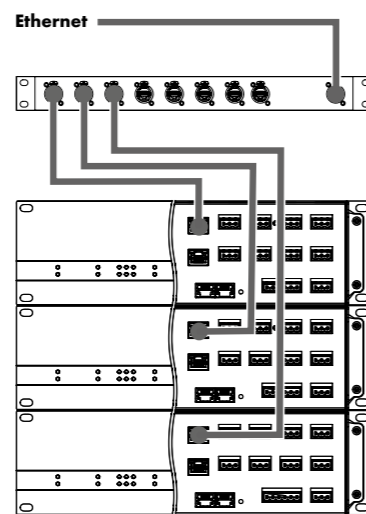

Star topology

The DS10 Audio network bridge The DS100 Signal Engine

DS10 Audio network bridge

The DS10 Audio network bridge interfaces between Dante networks and AES3 digital audio signals, while also providing distribution of Ethernet control data. Positioned within the signal chain in front of the amplifiers, this 1 RU device expands the d&b system approach. Each unit can deliver up to sixteen Dante network channels via AES3 digital signal outputs. Additionally, four AES3 input channels provide access to the Dante audio network for applications such as a break-in from a Front of House console.

The DS10 incorporates an integrated 5-port switch, offering a primary and redundant network for the Dante protocol, as well as advanced functions such as Multicast Filtering and VLAN modes. Using the DS10 Audio network bridge, audio signals and remote control data can be combined using a single Ethernet cable.

DS100 Signal Engine

The d&b DS100 Signal Engine is the platform underneath the Soundscape, based on a specialized rack mount 3 RU audio processor with Audinate Dante networking. It provides a 64 x 64 audio matrix with level and delay adjustments at all cross points. Additional software modules provide dynamic source positioning and emulated acoustics functions.

The DS100 is a versatile tool for use within complex audio systems to route and distribute multiple audio channels to numerous amplifiers driving loudspeaker positions and zones, show relay and break out rooms. The networking capabilities with a Dante enabled processor are significant, particularly for busy, multi-room complexes.

The DS100 completely integrates with the overall d&b system approach, including loudspeakers, amplifiers, rigging, transport and networking accessories and the DS10 Audio network bridge. The complete system is designed and optimized in the d&b ArrayCalc simulation software, and controlled via the d&b R1 Remote control software.



The DS10 Audio network bridge front view



The DS10 Audio network bridge rear view



The DS100 Signal Engine front view

The 10D/30D amplifiers

The d&b amplifiers are designed specifically to power d&b loudspeakers and are the beating heart of the d&b System Reality. As such, they incorporate Digital Signal Processing for comprehensive loudspeaker management, switchable filter functions, remote capabilities and user-definable controls, to fulfil the exact needs of each application.

Every loudspeaker configuration combines comprehensive system limiting, equalization and crossover settings to ensure consistent results and optimal performance. d&b amplifiers offer different output configurations for different loudspeaker setups, including Dual Channel mode, for passive setups, Mix TOP/SUB mode and 2-Way Active mode, to drive appropriate loudspeakers actively.

The d&b switch functions provide selected filters to precisely tailor a wide variety of setups to their applications. Examples of these switch functions are the CSA (Cardioid Subwoofer Array) and HFC (High Frequency Compensation) modes. CSA increases low frequency directivity control by minimising energy transmission towards the rear while HFC compensates for air absorption for loudspeakers covering far field listening positions. In addition to these functions, d&b amplifiers offer a comprehensive set of specific filters such as CUT, a cut mode for TOP loudspeakers when used with d&b subwoofers; CPL, to compensate for the coupling effect between loudspeakers in close proximity to other loudspeakers or hard objects and HFA mode, to attenuate the high frequencies of a loudspeaker to mimic the effect of far field listening. d&b amplifiers offer extended, user-definable equalization and delay capabilities, eliminating the need for external processing devices in the signal chain.

Sophisticated protection circuits modelling thermal and mechanical driver behaviour are provided, resulting in the sustained reliability of d&b systems. These amplifiers also have the functionality to enable system status monitoring and protection features, increasing the longevity of d&b systems. These features are designed for incorporation in applications specified to the requirements of sound systems for emergency purposes. A password protected LOCK function prevents unauthorized changes. The AutoStandby option automatically changes the amplifiers to Standby mode after a predefined time without any signal to individually specified inputs. The AutoWakeup function reactivates an amplifier when a digital input signal is active.

A powerCON¹ mains connector socket is fitted on the rear panel. The switch mode power supply of each amplifier incorporates mains overvoltage protection, inrush current limiting and loudspeaker protection at start up. Temperature and signal controlled fans cool the internal assemblies. d&b amplifiers offer analog and digital AES3 signal inputs with link outputs. The AES3 link output carries a refreshed signal, while a power fail relay is incorporated to prevent interruption of the signal chain, in the event of a power failure. All d&b amplifiers integrate with the d&b Remote network to enable the remote control and management of systems from anywhere within a network. Firmware updates containing new loudspeaker configurations or additional functions can be loaded to the amplifiers via the d&b Remote network.

For mobile and touring applications, the d&b D6, D20 and D80 amplifiers are recommended. Further information is available in the d&b D Amplifier and Software brochure, which is available to download from www.dbaudio.com.



10D amplifier



30D amplifier

Comparison of the d&b amplifiers

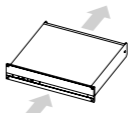
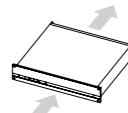
	10D	30D
Output channels	4	4
Input channels	4 x AES3 and 4 x analog	4 x AES3 and 4 x analog
Latency	0.3 msec	0.3 msec
User equalizers (per channel)	2 x 16-band	2 x 16-band
Delay	10 sec/3440 m	10 sec/3440 m
Configurations	Current d&b loudspeakers and linear mode except J-Series, V-Series, M2 and B2-SUB	Current d&b loudspeakers and linear mode
Maximum output power (THD+N < 0.5%, 12 dB crest factor)	4 x 350 W into 8 ohms 4 x 700 W into 4 ohms	4 x 800 W into 8 ohms 4 x 1600 W into 4 ohms
Output routing	Dual Channel, Mix TOP/SUB 2-Way Active	Dual Channel, Mix TOP/SUB 2-Way Active
Output connectors	Phoenix Euroblock	Phoenix Euroblock
GPIO connector, 5 ports	Phoenix Euroblock	Phoenix Euroblock
Fault contact	Phoenix Euroblock	Phoenix Euroblock
Cable compensation	LoadMatch	LoadMatch
Power supply	Universal range switched mode power supply with active PFC	Universal range switched mode power supply with active PFC
Mains voltage	100 - 240 V, 50 - 60 Hz	100 - 240 V, 50 - 60 Hz
Weight (kg/lb)	10.6/23.4	10.6/23.4
Dimensions	2 RU x 19" x 435 mm	2 RU x 19" x 435 mm
Remote	OCA via Ethernet/CAN	OCA via Ethernet/CAN
Airflow		

The 10D/30D amplifiers

Input routing

The 10D amplifier and 30D amplifier provide four analog inputs, four digital AES3 channels through two inputs as well as separate digital links, all on Euroblock connectors. The digital input pairs contain independent Sample Rate Converters (SRC). Each input features a separate input gain, meaning sources with various input sensitivities can be used without requiring an external mixing device. All eight individual inputs can be used simultaneously, then summed and routed to any of the four outputs.

System status monitoring

d&b amplifiers incorporate specific functions to check, monitor and control a d&b system. The System check feature can verify the status of a complete reinforcement system by measuring the impedance of the connected loudspeakers. Each driver in the system is checked and compared to the default impedance values for each particular cabinet. This calibration ensures that each loudspeaker performs within a tolerance band, and indicates possible damage to system components. The Input monitoring function can detect an incoming pilot signal regardless of whether this input is routed to an output. The Load monitoring function can detect a possible loudspeaker malfunction. This feature automatically checks load impedance to calculate individual driver status and report any failure. The Fallback and Override features ensure that any secondary or emergency signal is transmitted when required. The Fallback function ensures that the device will switch from the program material to an alternative source via a different input. The Override feature ensures that any general message or emergency signal takes priority. These functions can be triggered manually or automatically. These capabilities mean that the 10D and 30D amplifiers are suitable for applications specified to the requirements of evacuation systems for emergency purposes.

GPIO and General Fault Contact

The d&b installation amplifiers incorporate separate Euroblock connectors for General Purpose Input/Output (GPIO) and a fault contact. The GPIO connector offers five pins providing additional digital control lines which can be configured to be either an input or output. This enables the use of external devices to control and detect certain functionalities within the 10D and 30D amplifiers. The GPIOs can be configured to power the device, mute individual or all channels, change the AmpPreset or to check the Mains Voltage, Power or individual channel status. The separate fault contact allows a general device error to be remotely indicated.

Integrated Web Remote interface

The 10D and 30D amplifiers can be controlled via the integrated web interface, which enables the remote control of a single device using a browser window. Once the amplifier is connected to the d&b Remote network, an intuitive user interface becomes available after the IP address of the device is entered into the address bar of a web browser. Each amplifier in a system is managed individually, meaning that a new window or tab will be required for each device. The amplifiers can be accessed using a mobile device if the network features a wireless access point.

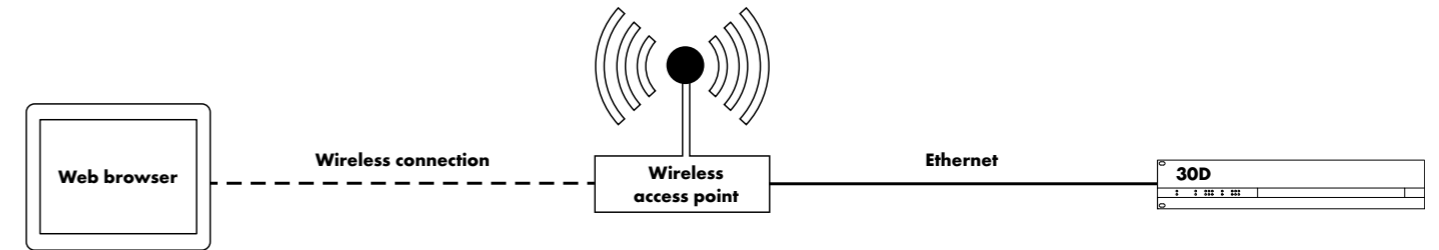

Application controlled via web browser for small setups

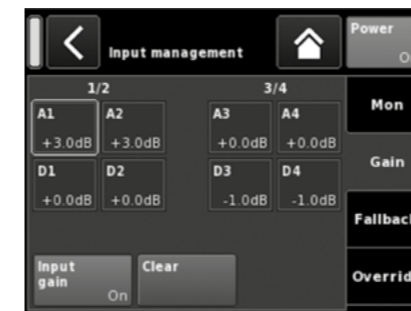

Input gain

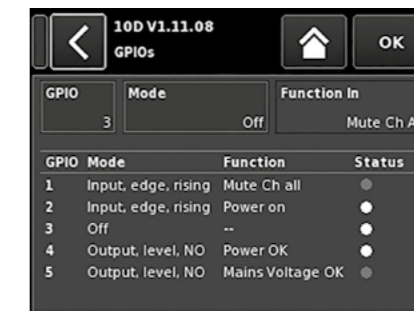

GPIOs

The 10D amplifier

The installation specific four channel 10D amplifier is intended for permanent integration with applications that require lower Sound Pressure Level (SPL) capabilities. The 10D shares the same Digital Signal Processing platform as the latest generation of d&b amplifiers, providing a linear mode as well as configurations for smaller d&b loudspeakers. For larger applications comprising the J-Series, V-Series, the M2 monitor and systems which require peak SPL output, the 30D installation specific amplifier is required. The DSP integrated within the 10D incorporates comprehensive loudspeaker management, switchable filtering functions as well as user definable equalization and delay capabilities. This includes two 16-band equalizers, providing optional parametric, asymmetric, shelving or notch filtering and up to 10 s (= 3440 m/11286 ft) signal delay, all of which can be applied independently to each channel.

The 10D is accessible via the d&b Remote network, either via Ethernet using the Open Control Architecture protocol (OCA) or CAN-Bus. The 10D is controlled using the integrated web interface, which enables access via a browser, or using the d&b R1 Remote control software. The device itself contains LEDs to display power, input, data and mute status.

The LoadMatch function integrated within the 10D amplifier electrically compensates for the properties of loudspeaker cable used. The 10D incorporates Class D amplifiers utilizing a power supply with active Power Factor Correction (PFC) suitable for mains voltages 100 V - 240 V, 50 - 60 Hz and maintains a stable output when used with weak or unstable mains supplies. Input and output connectors are all Euroblock sockets. The 10D integrates with the d&b Remote network using either the OCA via Ethernet protocol or CAN-Bus using RJ 45 connectors.

Control and indicators

POWERMains power switch
ISP, GR, OVL A/B LED indicators

Digital Signal Processing

Equalizer2 x 16-band PEQ/notch/shelving/asymmetric
Latency analog and digital inputs.....0.3 msec
Delay setting 0.3 - 10000 msec
Configurations.....current d&b loudspeakers and linear mode
..... except J-Series, V-Series, M2 and B2-SUB
Function switchesd&b loudspeaker specific circuits
Frequency generatorPink noise or Sine wave
Sampling rate.....96 kHz/27 Bit ADC/24 Bit DAC

Connectors

INPUT ANALOG (A1 - A4)3-pin male Phoenix Euroblock
ANALOG LINK (A1 - A4)3-pin male Phoenix Euroblock
INPUT DIGITAL (D1 - D4)3-pin male Phoenix Euroblock, AES3
DIGITAL LINK (Output)3-pin male Phoenix Euroblock, AES3
Sampling Digital AES348 kHz/96 kHz
SPEAKER OUTPUTS A/B/C/D4-pin Phoenix Euroblock female
CAN2 x RJ 45 parallel
ETHERNET2 x RJ 45, 10/100 Mbit Ethernet
GPIOs 1 - 5 and GND (6)6-pin Phoenix Euroblock male
FAULT contact.....3-pin Phoenix Euroblock male
Mains connector.....powerCON¹

Data (linear setting with subsonic filter)

Maximum output power per channel (THD + N < 0.5 %, all channels driven).....
CF = 6 dB at 4/8 ohms 2 x 700/350 W
CF = 12 dB at 4/8 ohms 2 x 700/350 W
S/N ratio (unweighted, RMS)
Analog input101 dBr
Digital input.....103 dBr

Power supply

Universal range switched mode power supply with active Power Factor Correction (PFC).....
Rated mains voltage 100 - 240 V, 50 - 60 Hz

Dimensions, weight

Height x width x depth.....2 RU x 19" x 435 mm/17.1"
Weight.....10.6 kg (23.4 lb)

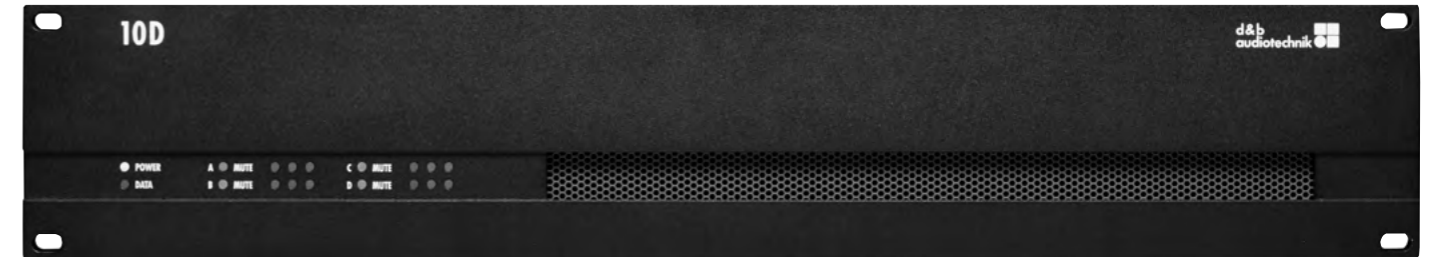

The 10D amplifier front view



The 10D amplifier rear view

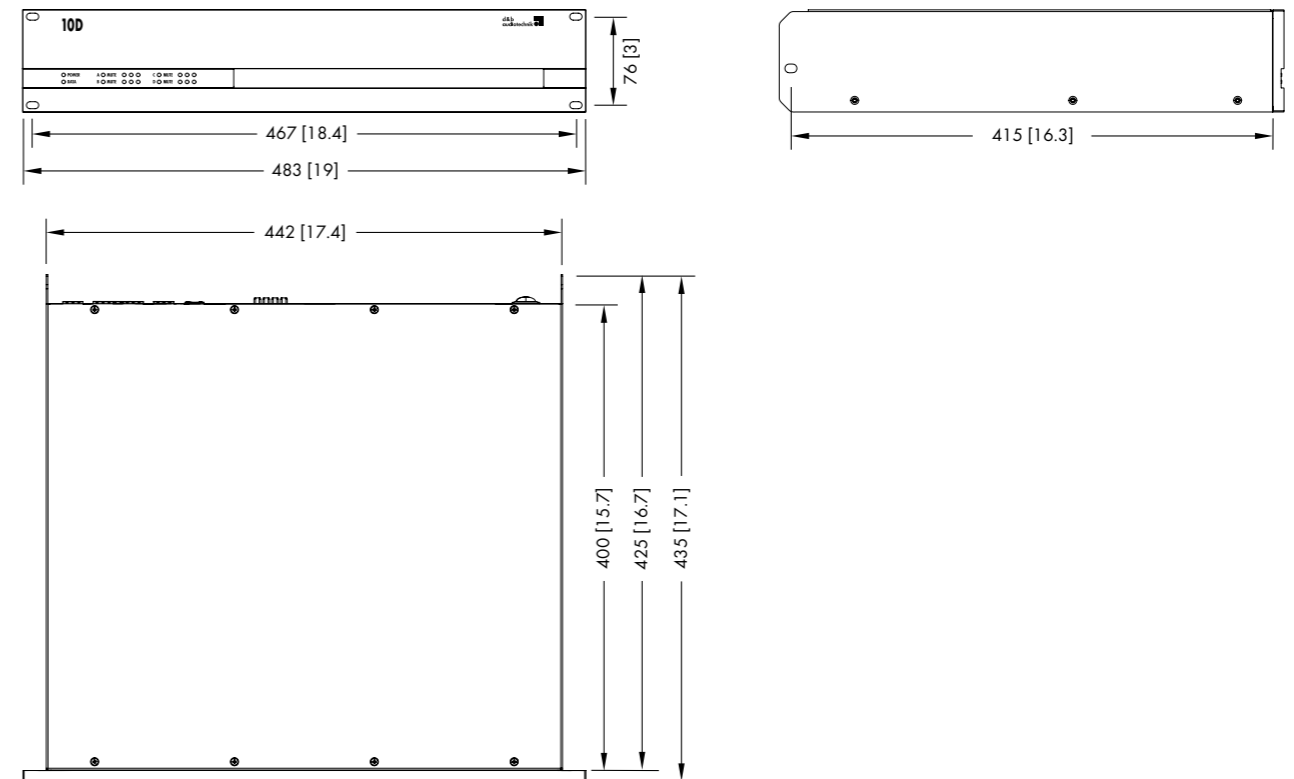

10D amplifier dimensions in mm [inch]

The 30D amplifier

The installation specific four channel 30D amplifier is intended for permanent integration with applications that require medium to high Sound Pressure Level (SPL) capabilities. The 30D shares the same Digital Signal Processing platform as the latest generation of d&b amplifiers, providing a linear mode as well as configurations for all d&b loudspeakers. Applications which demand the highest Sound Pressure Levels may require the higher output power of the d&b D80 amplifier.

The DSP integrated within the 30D incorporates comprehensive loudspeaker management, switchable filtering functions as well as user definable equalization and delay capabilities. This includes two 16-band equalizers, providing optional parametric, asymmetric, shelving or notch filtering and up to 10 s (= 3440 m/11286 ft) signal delay, all of which can be applied independently to each channel.

The 30D is accessible via the d&b Remote network, either via Ethernet using the Open Control Architecture protocol (OCA) or CAN-Bus. The 30D is controlled using the integrated web interface, which enables access via a browser, or using the d&b R1 Remote control software. The device itself contains LEDs to display power, input, data and mute status.

The LoadMatch function integrated within the 30D amplifier electrically compensates for the properties of loudspeaker cable used. The 30D incorporates Class D amplifiers utilizing a power supply with active Power Factor Correction (PFC) suitable for mains voltages 100 V - 240 V, 50 - 60 Hz and maintains a stable output when used with weak or unstable mains supplies. Input and output connectors are all Euroblock sockets. The 30D integrates with the d&b Remote network using either the OCA via Ethernet protocol or CAN-Bus using RJ 45 connectors.

Control and indicators

POWERMains power switch
ISP, GR, OVL A/B LED indicators

Digital Signal Processing

Equalizer2 x 16-band PEQ/notch/shelving/asymmetric
Latency analog and digital inputs0.3 msec
Delay setting 0.3 - 10000 msec
Configurationscurrent d&b loudspeakers and linear mode
Function switchesd&b loudspeaker specific circuits
Frequency generatorPink noise or Sine wave
Sampling rate 96 kHz/27 Bit ADC/24 Bit DAC

Connectors

INPUT ANALOG (A1 - A4)3-pin male Phoenix Euroblock
ANALOG LINK (A1 - A4)3-pin male Phoenix Euroblock
INPUT DIGITAL (D1 - D4)3-pin male Phoenix Euroblock, AES3
DIGITAL LINK (Output)3-pin male Phoenix Euroblock, AES3
Sampling Digital AES348 kHz/96 kHz
SPEAKER OUTPUTS A/B/C/D4-pin Phoenix Euroblock female
CAN2 x RJ 45 parallel
ETHERNET2 x RJ 45, 10/100 Mbit Ethernet
GPIOs 1 - 5 and GND (6)6-pin Phoenix Euroblock male
FAULT contact3-pin Phoenix Euroblock male
Mains connectorpowerCON¹

Data (linear setting with subsonic filter)

Maximum output power per channel (THD + N < 0.5 %, all channels driven)
CF = 6 dB at 4/8 ohms2 x 1000/800 W
CF = 12 dB at 4/8 ohms2 x 1600/800 W
S/N ratio (unweighted, RMS)
Analog input104 dBr
Digital input106 dBr

Power supply

Universal range switched mode power supply with active Power Factor Correction (PFC)
Rated mains voltage 100 - 240 V, 50 - 60 Hz

Dimensions, weight

Height x width x depth2 RU x 19" x 435 mm/17.1"
Weight 10.6 kg (23.4 lb)

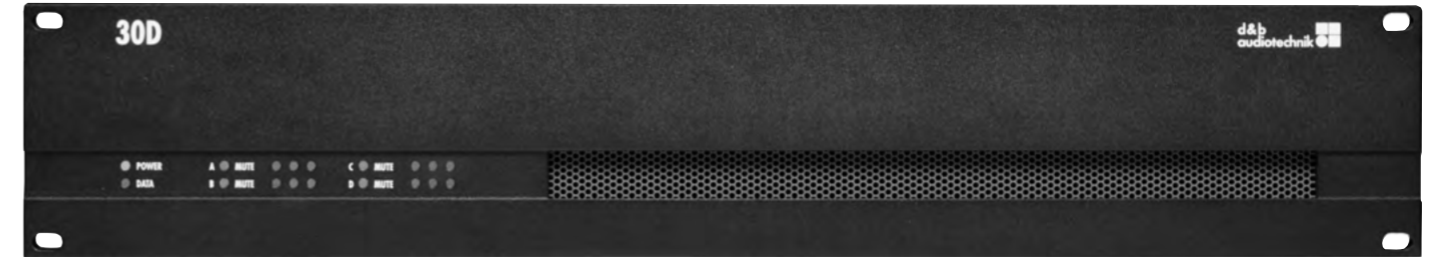

The 30D amplifier front view



The 30D amplifier rear view

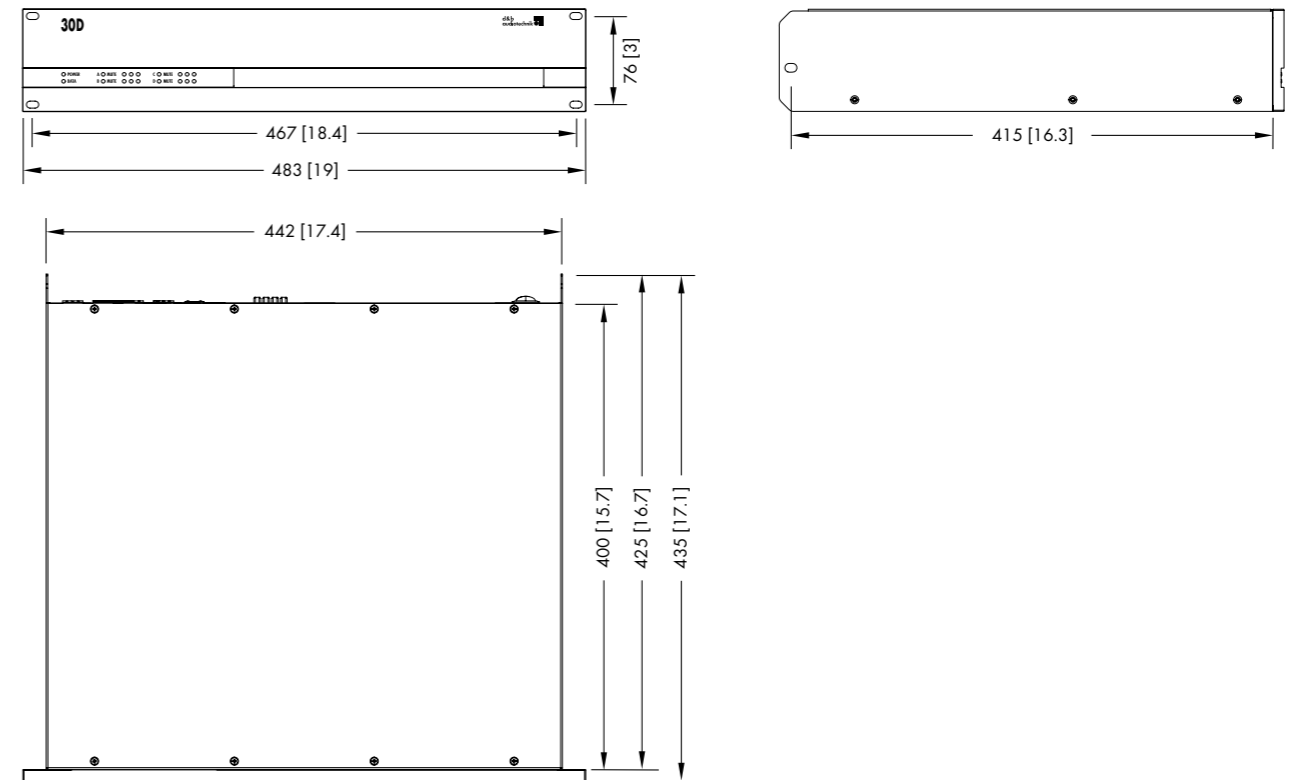

30D amplifier dimensions in mm [inch]

Installation amplifiers and software product overview

Amplifiers	Z2760.000	10D amplifier
	Z2760.400	10D amplifier China
	Z2760.500	10D amplifier USA
	Z2770.000	30D amplifier
	Z2770.400	30D amplifier China
	Z2770.500	30D amplifier USA
Processing and distribution	Z4010.000	DS10 Audio network bridge
	Z4100.000	DS100 Signal Engine
Amplifier accessories	Z2622.000	Accessory kit for 10D/30D Euroblock Phoenix connectors
Remote network	Z6118.000	R60 USB to CAN interface
	Z6124.000	R70 Ethernet to CAN interface

