

xA

xA-Series

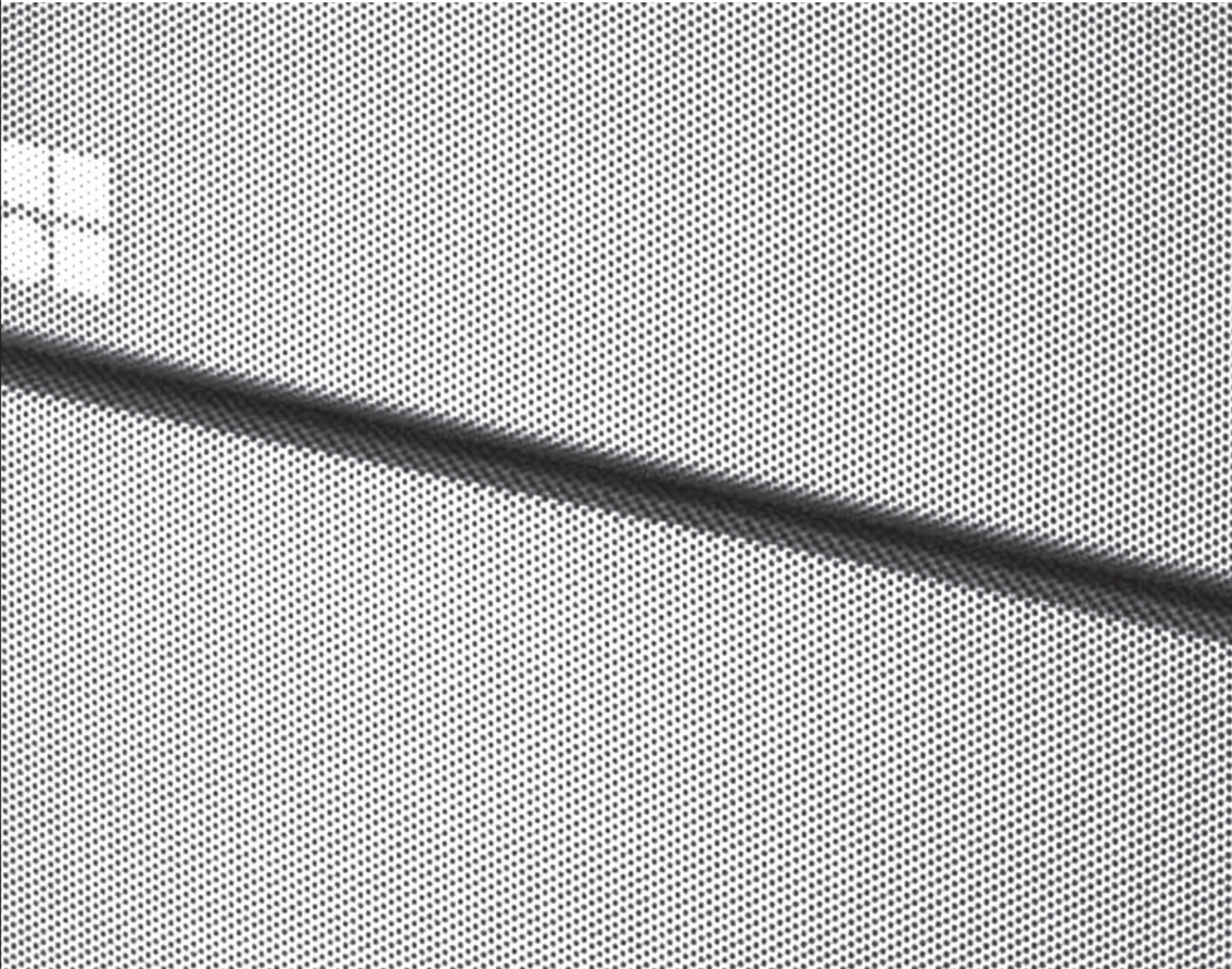

Contents

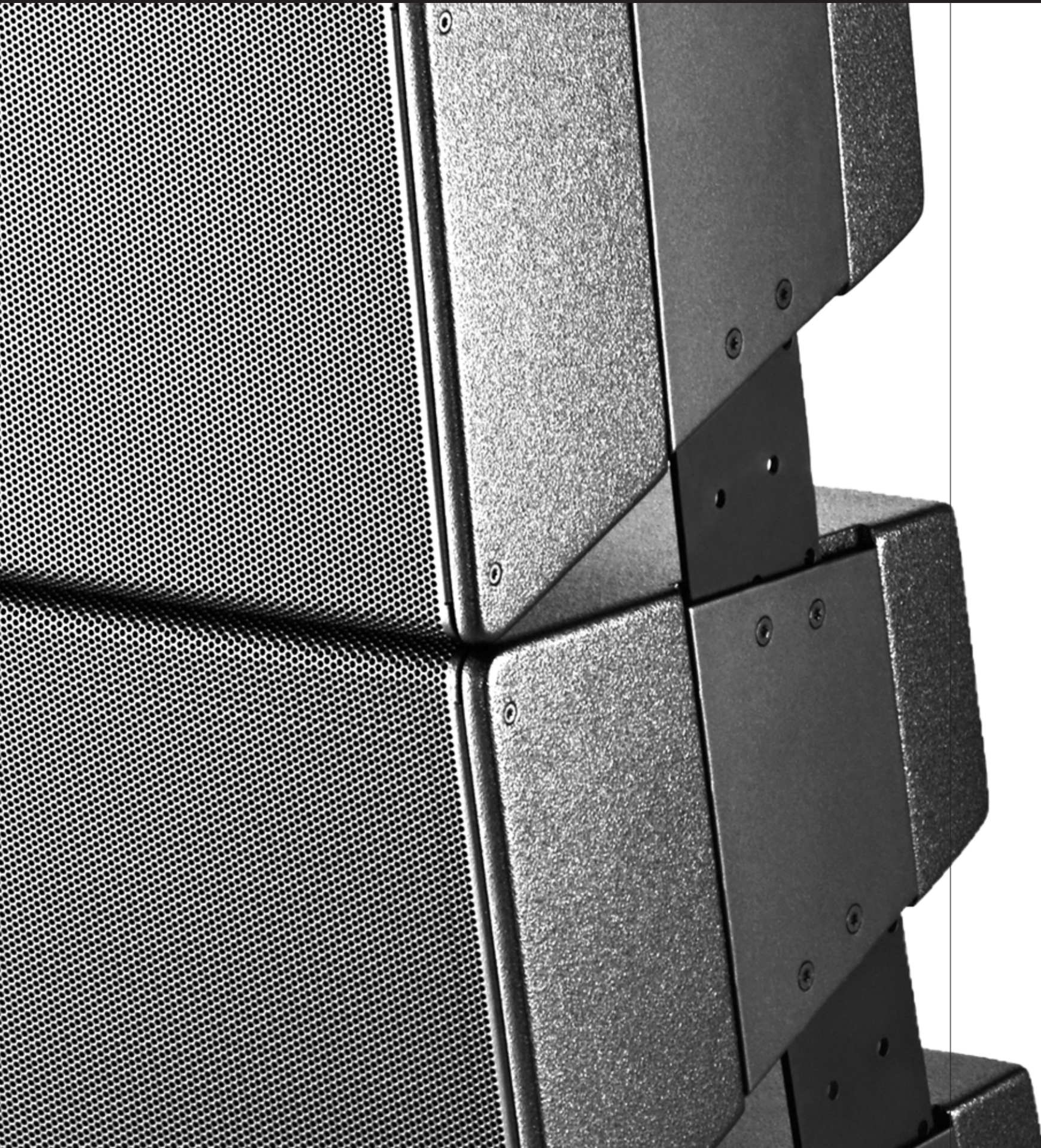

| | |
|---|----|
| The d&b System reality | 4 |
| The xA-Series | 6 |
| The 10A/10A-D loudspeakers | 10 |
| The 10AL/10AL-D loudspeakers | 11 |
| The 18A subwoofer | 12 |
| The 27A subwoofer | 13 |
| The xA-Series rigging accessories and examples | 14 |
| The d&b ArrayCalc simulation software | 16 |
| The d&b R1 Remote control software | 17 |
| The d&b amplifiers | 18 |
| The operation with d&b amplifiers | 20 |
| The xA-Series frequency responses | 21 |
| The d&b amplifier output modes | 22 |
| The DS10 Audio network bridge | 24 |
| The DS100 Signal Engine | 24 |
| The xA-Series configuration examples | 25 |
| The xA-Series product overview | 27 |

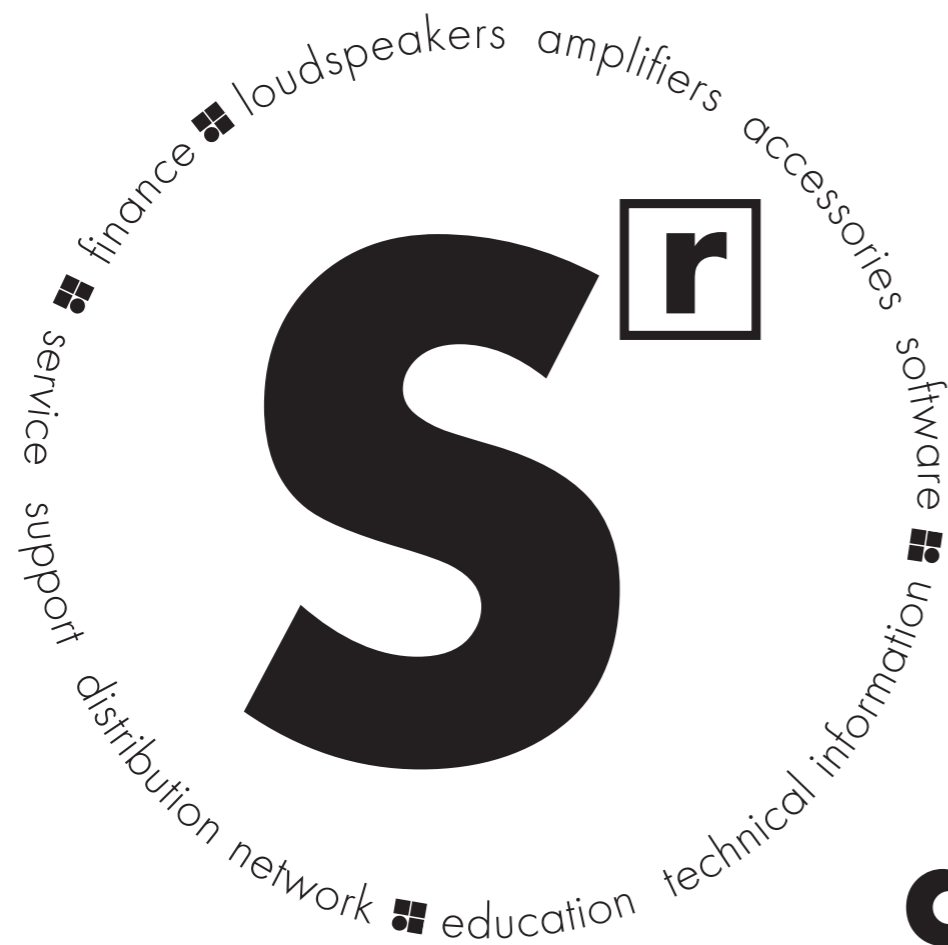

d&b System reality

As the name implies a d&b audiotechnik system is not just a loudspeaker. Nor is it merely a sum of the components: loudspeakers, amplifiers, signal processors, networking, software and accessories. Right from the outset the d&b audiotechnik approach was to build integrated sound reinforcement systems

that actually are more than the combination of parts: an entirety where each fits all. Every element is tightly specified, precisely aligned and carefully matched to achieve maximum efficiency. For ease of use, all the user-definable parameters are incorporated, allowing the possibility of adjustment, either

directly, via remote control surfaces, or integrated within wider networks. Neutral sound characteristics leave the user all the freedom needed to realize whatever the brief. At the same time d&b offers finance, service and support, a knowledgeable distribution network, education and training as well as technical

information, so the same optimal acoustic result is achieved consistently by every system anywhere, at any time. In reality: the d&b System reality.



The mechanically arrayable **xA-Series** loudspeakers are designed for visual, physical, acoustical and electrical integration into permanently installed applications and are intended for environments that go beyond rider specified performance spaces.

The loudspeakers share the same clean and unobtrusive industrial design and are equipped with an integrated rigging system for the design of vertical arrays providing application specific dispersion and coverage characteristics. A direct radiating



LF/MF is utilized in combination with different HF dispersion technologies including line source waveguides. Both the cabinets and available accessories can be properly colour matched to interior designs. Intended applications include town halls,

theatres and opera houses, ball rooms, houses of worship, small to medium sized sports venues and night clubs, lecturer theatres and assembly halls.

The xA-Series

The xA-Series loudspeakers are 2-way, passive high performance cabinets employing a single 10" driver in a bass-reflex enclosure and offer different HF sections that enable the design of vertical or horizontal point source arrays as well as vertical line arrays. The biaxial **10A/10A-D** are point source cabinets that have rotatable horns delivering additional flexibility in terms of the placement options of the loudspeakers. Whilst the biaxial **10AL/10AL-D** line source loudspeakers enable the design of line arrays offering vertical and horizontal coverage tailored to specific reinforcement tasks.



10A/10A-D loudspeaker



10AL/10AL-D loudspeaker

The xA-Series loudspeakers are supported by the compact bass-reflex subwoofers **18A-SUB** and **27A-SUB** of which the 27A-SUB has an integrated cardioid setup. The 18A and 27A subwoofers rigging hardware allow them to be integrated into vertical 10A/10A-D and 10AL/10AL-D arrays or used as stand-alone columns. The 18A-SUB completes all program material with that deep, round, warm and musical low end of today's performance expectations. The 27A-SUB's patented cardioid dispersion avoids unwanted energy behind the system and greatly reduces the reverberant field at low frequencies providing highest accuracy in low frequency reproduction. The special passive cardioid design of the 27A-SUB can be powered by a single amplifier channel only and offers a highly economic medium sized subwoofer.



18A subwoofer



27A subwoofer

The xA-Series cabinets and accessories are available with a Weather Resistant (WR) and special colour (SC) option. The WR option provides an IP34 rating, and enables operation of loudspeakers in changing ambient conditions, however it is not intended to enable permanent, unprotected operation of loudspeakers outdoors. The Weather Resistant cabinet is supplied with a fixed cable with a PG cable gland, coated with PCP (Polyurea Cabinet Protection) and is available in black only. The SC option for all loudspeaker cabinets and most accessories can be executed in all RAL colours.

The d&b software offering aids the entire system setup process. The **d&b ArrayCalc Simulation software** allows the virtual optimization of loudspeaker line arrays, point source and column loudspeakers as well as subwoofers and their adjustment to venue conditions. The configuration simulated in ArrayCalc is assimilated by the **d&b R1 Remote control software** into an intuitive graphical user interface to manage the whole system from anywhere in the venue.

d&b amplifiers are specifically designed for use with d&b loudspeakers, and are at the heart of the d&b system approach. These devices containing extensive Digital Signal Processing capabilities to provide comprehensive loudspeaker management and specific switchable filter functions to precisely target the system response for a wide variety of applications. The installation specific four channel **30D** amplifier is intended for permanent integration within venues which require medium to high Sound Pressure Levels. It provides extensive user-definable equalization containing two 16-band equalizers with parametric, notch, shelving and asymmetric filters as well as delay capabilities of up to 10 seconds. The 30D is accessible via the intuitive web interface through a browser as well as the R1 Remote control software.



30D amplifier

The **DS10 Audio network bridge** provides 16 AES3 outputs and interfaces between the Dante audio transport protocol and the d&b amplifiers.



DS10 Audio network bridge

The **DS100 Signal Engine** is based on a specialized rack mount 3 RU audio processor with Audinate Dante networking. It provides a 64 x 64 audio matrix with level and delay adjustments at all cross points. Additional software modules provide dynamic source positioning and emulated acoustics functions.



DS100 Signal Engine

The 10A/10A-D loudspeakers

10A/10A-D loudspeaker

The biaxial 10A/10A-D are high performance 2-way point source loudspeakers employing a single 10" driver in a bass-reflex enclosure and different HF sections for a wide range of installed sound applications. All models are lightweight passive designs using neodymium drivers and large constant directivity horns for accurate pattern control. The 10A/10A-D are arrayable cabinets with rotatable dispersion characteristics of 75° x 50° and 110° x 55° respectively.

With their frequency response from 60 Hz to 18 kHz both versions can be used as full range systems or be supplemented by different subwoofers from either the xS or xA-Series. The 18A or 27A subwoofers can also be integrated into the array.

The enclosures are constructed from marine plywood with an impact resistant black paint finish. The front of the loudspeaker cabinets are protected by a rigid metal grill backed by an acoustically transparent foam, whilst the side panels have an integrated rigging system. The loudspeakers are Ball Impact Resistant according to DIN 18032-3 for sports and multipurpose halls.

System data 10A • 10A-D

| | |
|--|-----------------|
| Frequency response (-5 dB standard)..... | 60 Hz - 18 kHz |
| Frequency response (-5 dB CUT mode)..... | 100 Hz - 18 kHz |
| Max. sound pressure (1 m, free field) ¹ | |
| with D6/10D | 127 • 127 dB |
| with 30D/D20 | 130 • 130 dB |
| with D80 | 130 • 130 dB |
| Input level (100 dB SPL/1 m) | -12 dBu |

Loudspeaker data

| | |
|--|--------------------------------------|
| Nominal impedance | 12 ohms |
| Power handling capacity (RMS/peak 10 msec) | 200/1200 W |
| Nominal dispersion angle 10A/10A-D (h x v) | |
| | 75° x 50°/110° x 55° rotatable |
| Components | 10" driver with neodymium magnet |
| | 1.4" compression driver with CD horn |
| | passive crossover network |
| Connections | 2 x NL4 |
| | screw terminal block |
| Weight | 14 kg (31 lb) |

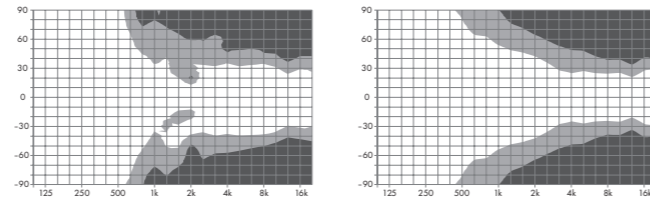

10A horizontal dispersion characteristics²

10A vertical dispersion characteristics²

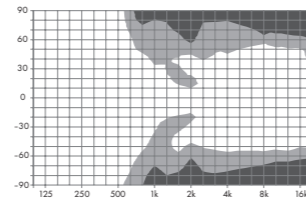

10A-D horizontal dispersion characteristics²

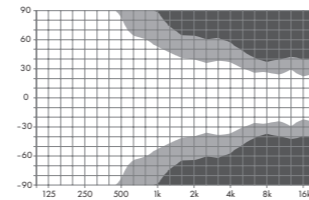

10A-D vertical dispersion characteristics²

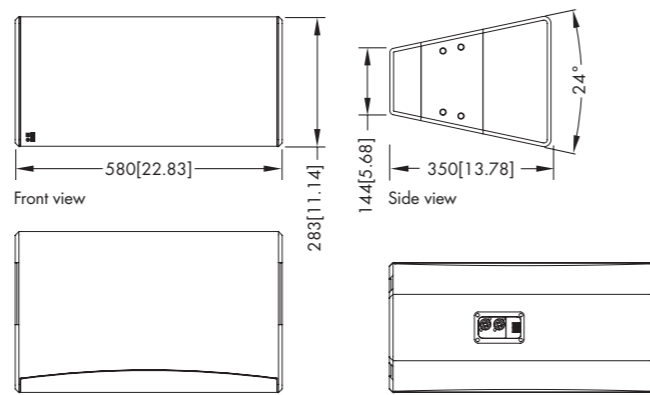

10A/10A-D cabinet dimensions in mm [inch]

¹ Broadband measurement, pink noise, crest factor 4, peak measurement, linear weighting
² Dispersion angle vs frequency plotted using lines of equal sound pressure (isobars) at -6 dB and -12 dB

The 10AL/10AL-D loudspeakers

10AL/10AL-D loudspeaker

The biaxial 10AL/10AL-D loudspeakers are high performance 2-way line array modules. They employ a single 10" driver in a bass-reflex enclosure and constant directivity HF line sources with either 75° or 105° horizontal coverage respectively using dual 1" exit drivers. All models are lightweight passive designs using neodymium drivers, with large constant directivity horns for accurate pattern control.

With their frequency response from 60 Hz to 18 kHz both versions can be used as full range systems or be supplemented by different subwoofers from either the xS or xA-Series to extend bandwidth and headroom. The 18A or 27A subwoofers can also be integrated into the array.

The enclosures are constructed from marine plywood with an impact resistant black paint finish. The front of the loudspeaker cabinets are protected by a rigid metal grill backed by an acoustically transparent foam, whilst the side panels have an integrated rigging system. The loudspeakers are Ball Impact Resistant according to DIN 18032-3 for sports and multipurpose halls.

System data 10AL • 10AL-D

| | |
|--|-----------------|
| Frequency response (-5 dB standard)..... | 60 Hz - 18 kHz |
| Frequency response (-5 dB CUT mode)..... | 110 Hz - 18 kHz |
| Max. sound pressure (1 m, free field) ¹ | |
| with D6/10D | 130 • 129 dB |
| with 30D/D20 | 133 • 132 dB |
| with D80 | 133 • 132 dB |
| Input level (100 dB SPL/1 m) | -16 dBu |

Loudspeaker data

| | |
|--|--|
| Nominal impedance | 12 ohms |
| Power handling capacity (RMS/peak 10 msec) | 200/1200 W |
| Nominal dispersion angle 10AL/10AL-D (h)..... | 75°/105° |
| Components | 10" driver with neodymium magnet |
| | 2 x 1" exit compression drivers with CD horn |
| | passive crossover network |
| Connections | 2 x NL4 |
| | screw terminal block |
| Weight | 14 kg (31 lb) |

¹ Broadband measurement, pink noise, crest factor 4, peak measurement, linear weighting
² Dispersion angle vs frequency plotted using lines of equal sound pressure (isobars) at -6 dB and -12 dB

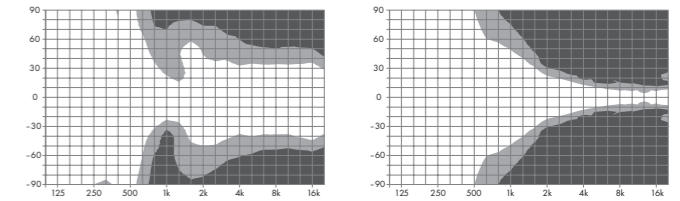

10AL horizontal dispersion characteristics²

10AL vertical dispersion characteristics²

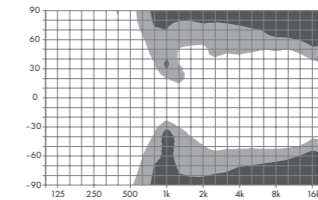

10AL-D horizontal dispersion characteristics²

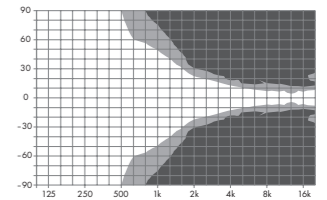

10AL-D vertical dispersion characteristics²

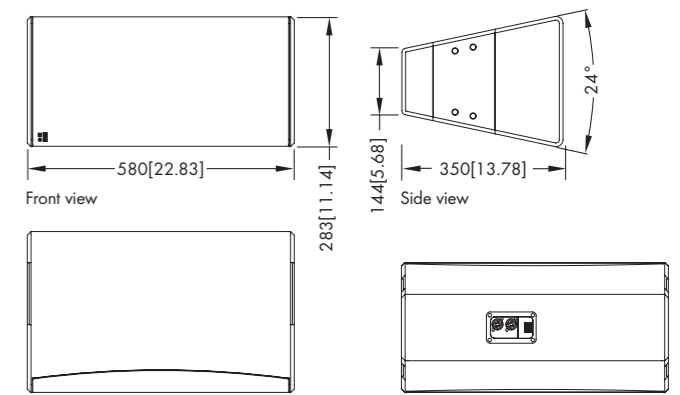

10AL/10AL-D cabinet dimensions in mm [inch]

The 18A subwoofer

18A subwoofer

The 18A-SUB is a compact high performance subwoofer for use with the xA-Series loudspeakers. The cabinet houses a long excursion 18" neodymium driver in a bass-reflex design. The 18A-SUB can be used stand-alone, stacked or as a base for a mixed ground stack. It can also be combined with 10A and 10AL loudspeakers in vertical flown arrays. The enclosure is constructed from marine plywood with an impact resistant black paint finish. The front of the loudspeaker cabinet is protected by a rigid metal grill backed by an acoustically transparent foam, whilst the side panels have an integrated rigging system. The loudspeaker is Ball Impact Resistant according to DIN 18032-3 for sports and multipurpose halls.

System data

Frequency response (-5 dB standard)37 - 140 Hz
 Frequency response (-5 dB 100 Hz mode).....37 - 100 Hz
 Max. sound pressure (single cabinet, 1 m, free field)¹
 with D6/10D 129 dB
 with 30D/D20..... 132 dB
 with D80 132 dB

Loudspeaker data

Nominal impedance8 ohms
 Power handling capacity (RMS/peak 10 msec)400/1600 W
 Components18" driver with neodymium magnet
 Connections2 x NL4
 screw terminal block
 Weight..... 32 kg (71 lb)

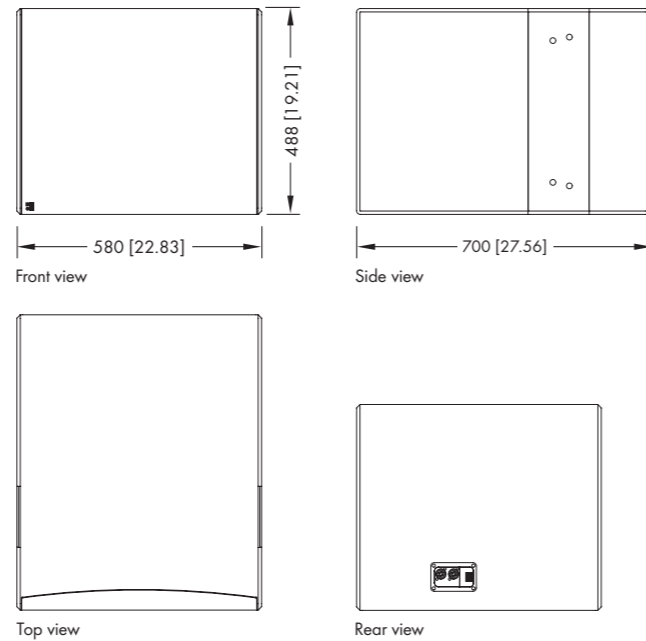

18A-SUB cabinet dimensions in mm [inch]

The 27A subwoofer

27A subwoofer

The 27A-SUB is a compact high performance cardioid subwoofer for use with the xA-Series loudspeakers. The cabinet houses two long excursion neodymium drivers in an integrated cardioid setup: a 15" driver in a bass-reflex design facing to the front and a 12" driver in a two chamber bandpass design radiating to the rear. The arrangement and tuning provide a cardioid dispersion pattern using a single amplifier channel. The 27A-SUB can be used stand-alone, stacked or as a base for a mixed ground stack. It can also be combined with 10A and 10AL loudspeakers in vertical flown arrays. The enclosure is constructed from marine plywood with an impact resistant black paint finish. The front of the loudspeaker cabinet is protected by a rigid metal grill backed by an acoustically transparent foam, whilst the side panels have an integrated rigging system. The loudspeaker is Ball Impact Resistant according to DIN 18032-3 for sports and multipurpose halls.

System data

Frequency response (-5 dB standard)40 - 140 Hz
 Frequency response (-5 dB 100 Hz mode).....40 - 100 Hz
 Max. sound pressure (single cabinet, 1 m, free field)¹
 with D6/10D 128 dB
 with 30D/D20..... 131 dB
 with D80 131 dB

Loudspeaker data

Nominal impedance6 ohms
 Power handling capacity (RMS/peak 10 msec)500/2000 W
 Components
 front/rear 15"/12" driver with neodymium magnet
 Connections2 x NL4
 screw terminal block
 Weight..... 41 kg (90 lb)

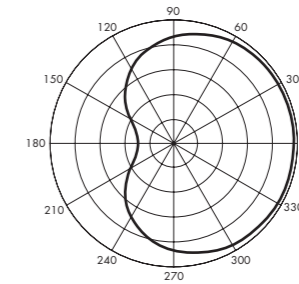

Cardioid polar pattern

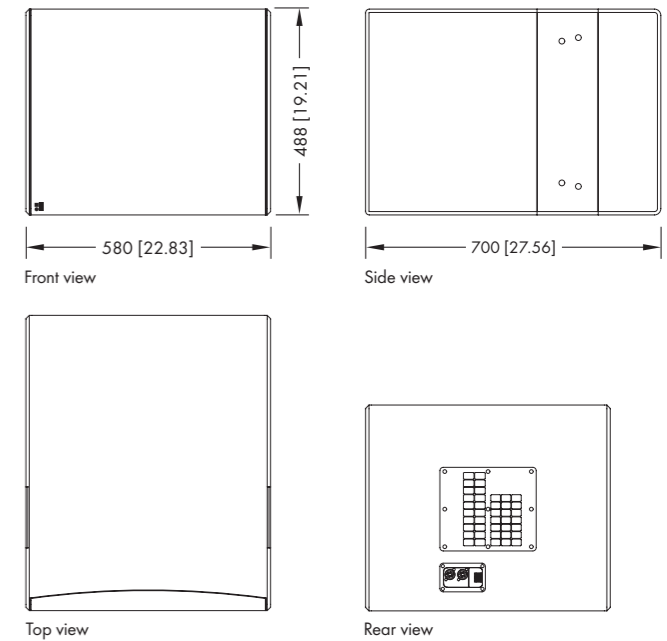

27A-SUB cabinet dimensions in mm [inch]

The xA-Series rigging accessories

Safety approval

d&b loudspeakers and accessories are designed for setup and use within situations requiring compliance with the provisions and directives of the DGUV regulation 17 (formerly BGV C1).

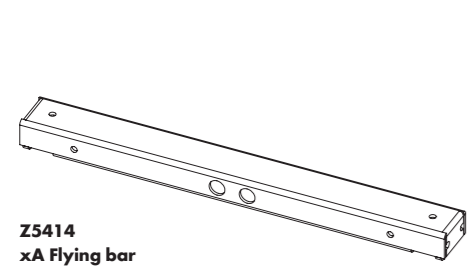

Z5414
xA Flying bar

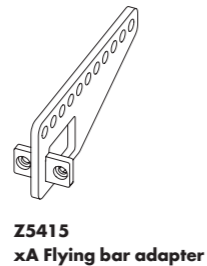

Z5415
xA Flying bar adapter

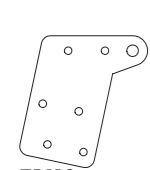

Z5413
xA Flying bar connector plate

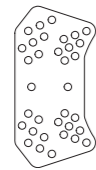

Z5416
10A Connector plate
Splay angle 25° to 60°

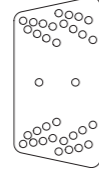

Z5417
10AL Connector plate
Splay angle 0° to 15°



Z5418
xA-SUB Connector plate
Splay angle 0° to 5°

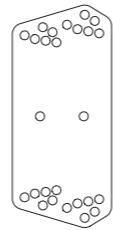

Z5421
xA Connector plate
negative splay
Splay angle 0° to -9°

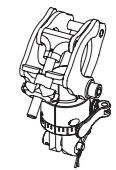

Z5147
Rota clamp
WLL: 500 kg (1100 lb)
for a tube diameter up to
51 mm/2"

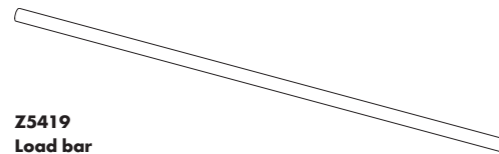

Z5419
Load bar



Z5420
Load eyebolt

The xA-Series rigging examples

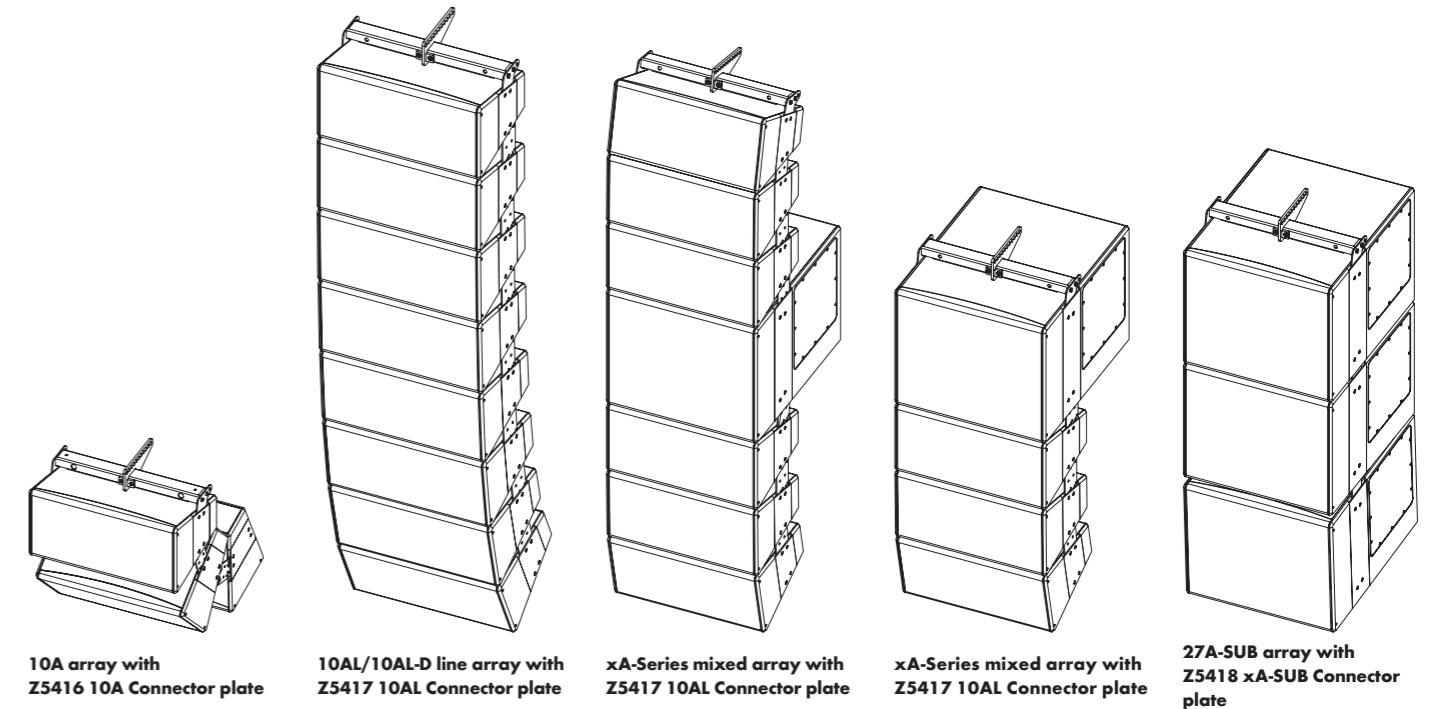

10A array with Z5416 10A Connector plate 10AL/10AL-D line array with Z5417 10AL Connector plate xA-Series mixed array with Z5417 10AL Connector plate xA-Series mixed array with Z5417 10AL Connector plate 27A-SUB array with Z5418 xA-SUB Connector plate

All the above are arrayed using Z5413 xA Flying bar connector plate, Z5414 xA Flying bar and Z5415 xA Flying bar adapter

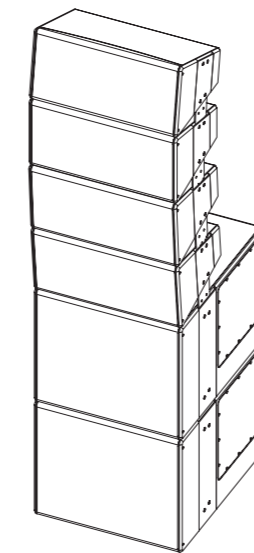

10AL/27A-SUB ground stack
Z5417/Z5418
10AL/xA-SUB Connector plate
Z5421 xA Connector plate
negative splay

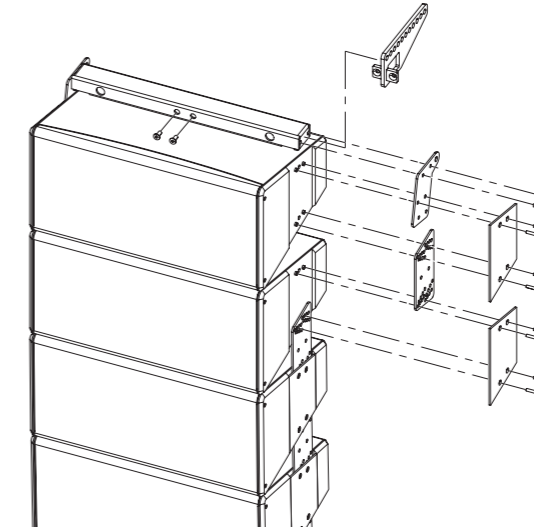

10AL line array with
Z5414 xA Flying bar
Z5415 xA Flying bar adapter
Z5413 xA Flying bar connector plate
Z5417 10AL Connector plate

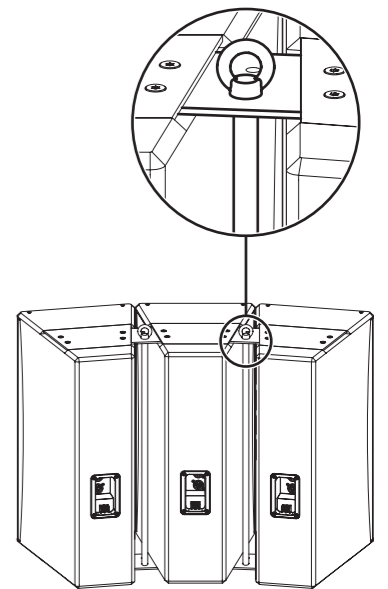

10AL array with
Z5419 Load bar
Z5420 Load eyebolt
Z5417 10AL Connector plate

The d&b ArrayCalc simulation software

The d&b ArrayCalc simulation software is the simulation tool for d&b line arrays, column and point source loudspeakers as well as subwoofers. This is a comprehensive toolbox for all tasks associated with acoustic design, performance prediction, alignment, rigging and safety parameters. d&b ArrayCalc is available as a native stand-alone application for both Microsoft Windows¹ and Mac OS X² operating systems. In combination with the d&b Remote network, this can significantly reduce setup and tuning time and allows for precise initial simulations when planning installations. Listening planes can be defined in the venue tab, creating a three dimensional representation of any audience area in a given venue. All sources can be time aligned, and the phase response of a flown system and a ground stacked SUB array can be aligned at a definable reference point.

The comprehensive simulation precisely models the actual performance of the system, taking into account input level, all system configuration options (such as CUT, CPL, HFC or INFRA), limiter headroom and air absorption. Acoustic obstacles, such as video screens, can be added to a model. Acoustic shadowing, whether by these obstacles, or a balcony overhang, is taken into consideration. The level distribution resulting from the interaction of all active sources can be mapped onto the audience areas in a three-dimensional view. The Remote ID for all devices can be managed in the amplifier tab. EASE and DXF data export capabilities are also available.

The R1 Remote control software uses the data defined in ArrayCalc to generate an intuitive graphical user interface including the complete setup of the simulated system and all configuration information. This workflow removes the need to manually transfer data from one software program to the other. Further information is provided in the d&b Amplifier and Software brochure which is available for download at www.dbaudio.com.

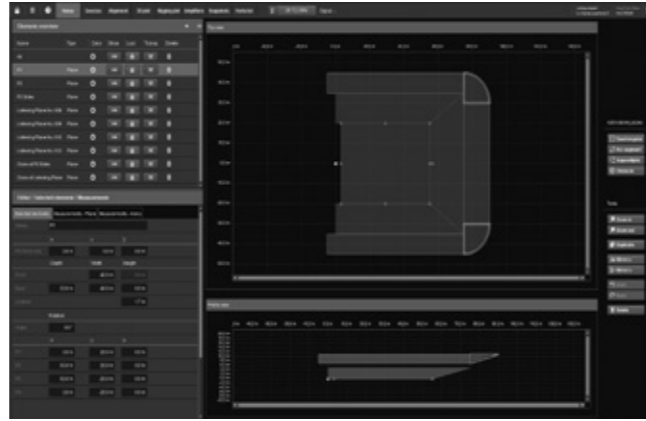

Venue

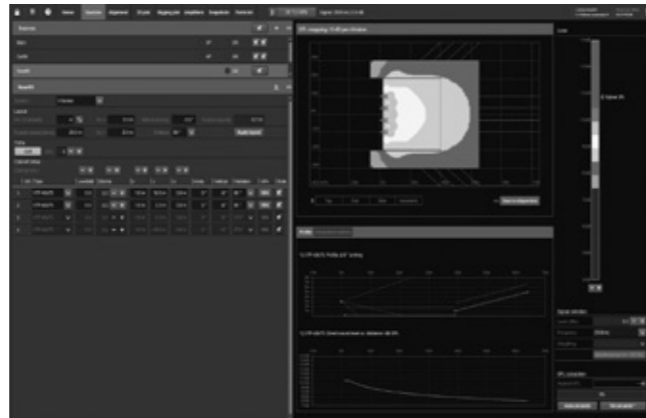

Sources, point sources

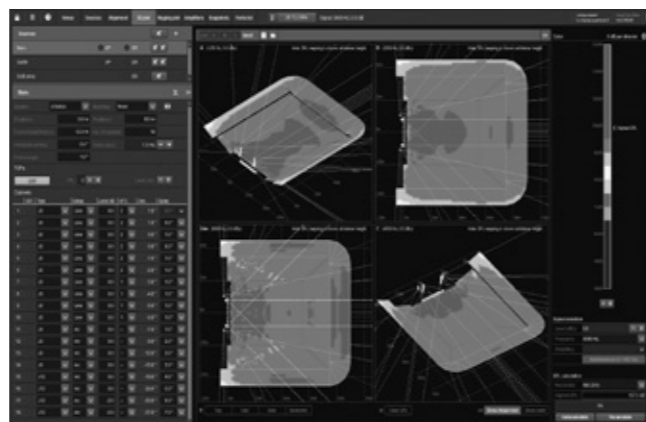

3D Plot quad

The d&b R1 Remote control software

The remote control capability of the d&b Remote network enables central control and monitoring of a complete d&b loudspeaker system from anywhere in the network, be it from a computer in the control room, at the mix position, or on a wireless tablet in the auditorium. This central access to all functions through the d&b Remote network, to controls as well as detailed system and device diagnostics information, unlocks the full potential of the d&b system approach. In a typical user workflow, the d&b Remote network takes settings optimized in the ArrayCalc Simulation software and applies these to all the amplifiers within the network. The importation of settings from ArrayCalc allows the system configuration to be quickly accomplished, providing more time for verification and fine tuning.

All features, functions and controls available on the front panel of d&b amplifiers may be remotely controlled and/or monitored using R1 Remote control software. This allows each channel of the amplifier to be controlled and enables the creation of groups of loudspeakers. When grouped together, a button or fader can control the overall system level, zone level, equalization and delay, power ON/OFF, MUTE, as well as loudspeaker specific function switches such as CUT/HFA/HFC and CPL. An offline mode is provided for preparation in advance of an event, without the amplifiers being present or connected.

For mobile applications, d&b System check verifies that the system performs within a predefined condition. Extensive facilities for storing and recalling system settings are provided allowing these to be repeated, as and when required. Project files can be easily adjusted for use with a different set of equipment at another location.

In installation projects system integrators can configure the d&b Remote network to offer access to different levels of control, tailored to the operational demands. For example, power ON/OFF for daily use, or more complex functionality for detailed control. Password protection is available to restrict access. Input and Load monitoring allow installation operators to ensure optimum performance at all times.

R1 Remote control software enables d&b amplifiers to be remotely controlled using both Ethernet and CAN-Bus in parallel. The software is optimized for use with touch screen, mouse and keyboard and runs on both Microsoft Windows¹ (Win7 or higher) and Mac OS X² (10.7 or higher) operating systems. Further information is provided in the d&b Amplifier and Software brochure which is available for download at www.dbaudio.com.



Home



Remote in Configuration mode



16-band equalizer

¹ Microsoft Windows is a registered trademark or trademark of Microsoft Corporation in the United States and/or other countries

² Mac OS X is a trademark of Apple Inc., registered in the U.S. and other countries

¹ Microsoft Windows is a registered trademark or trademark of Microsoft Corporation in the United States and/or other countries

² Mac OS X is a trademark of Apple Inc., registered in the U.S. and other countries

The d&b amplifiers

The d&b amplifiers are designed specifically to power d&b loudspeakers and are the beating heart of the d&b System reality. As such, they incorporate Digital Signal Processing for comprehensive loudspeaker management, switchable filter functions, remote capabilities and user-definable controls, to fulfil the exact needs of each application. Every loudspeaker configuration combines comprehensive system limiting, and equalization and crossover settings to ensure consistent results and optimal performance. d&b amplifiers offer

different output configurations for different loudspeaker setups, including Dual Channel mode, for passive setups, Mix TOP/SUB mode, in which two channels are driven through a single output connector, and 2-Way Active mode, which also sends the output of two channels down one connector to drive appropriate loudspeakers actively. The d&b switch functions provide selected filters to precisely tailor a wide variety of setups to their applications. Examples of these switch functions are the CSA (Cardioid Subwoofer Array)

and HFC (High Frequency Compensation) modes. CSA increases low frequency directivity control by minimising energy transmission towards the rear while HFC compensates for air absorption for loudspeakers covering far field listening positions. In addition to these functions, d&b amplifiers offer a comprehensive set of specific filters such as CUT, a cut mode for TOP loudspeakers when used with d&b subwoofers; CPL, to compensate for the coupling effect between loudspeakers in close proximity to other loudspeakers or hard objects and HFA

mode, to attenuate the high frequencies of a loudspeaker to mimic the effect of far field listening. These devices offer extended, user-definable equalization and delay capabilities, eliminating the need for external processing devices in the signal chain. All d&b amplifiers integrate with the d&b Remote network to enable the remote control and management of systems from anywhere within a network. Further information is provided in the d&b Amplifier and Software brochure which is available for download at www.dbaudio.com.

Comparison of the d&b amplifiers

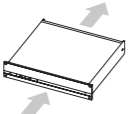
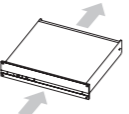
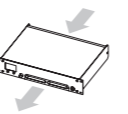
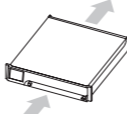
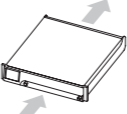
| | 30D | 10D | D6 | D20 | D80 |
|---|---|---|---|---|---|
| User interface | LED indicators | LED indicators | Encoder/LC display | Encoder/colour TFT touchscreen | Encoder/colour TFT touchscreen |
| Output channels | 4 | 4 | 2 | 4 | 4 |
| Input channels | 4 x AES3 and 4 x analog | 4 x AES3 and 4 x analog | 2 x AES3 or 2 x analog | 4 x AES3 or 4 x analog or 2 x AES3 and 2 x analog | 4 x AES3 or 4 x analog or 2 x AES3 and 2 x analog |
| Latency | 0.3 msec | 0.3 msec | 0.3 msec | 0.3 msec | 0.3 msec |
| User equalizers (per channel) | 2 x 16-band | 2 x 16-band | 4-band | 2 x 16-band | 2 x 16-band |
| Delay | 10 sec/3440 m | 10 sec/3440 m | 340 msec/116.9 m | 10 sec/3440 m | 10 sec/3440 m |
| Maximum output power (THD+N < 0.5%, 12 dB crest factor) | 4 x 800 W into 8 ohms 4 x 1600 W into 4 ohms | 4 x 350 W into 8 ohms 4 x 700 W into 4 ohms | 2 x 350 W into 8 ohms 2 x 600 W into 4 ohms | 4 x 800 W into 8 ohms 4 x 1600 W into 4 ohms | 4 x 2000 W into 8 ohms 4 x 4000 W into 4 ohms |
| Output routing | Dual Channel, Mix TOP/SUB 2-Way Active | Dual Channel, Mix TOP/SUB 2-Way Active | Dual Channel | Dual Channel, Mix TOP/SUB 2-Way Active | Dual Channel, Mix TOP/SUB 2-Way Active |
| Output connectors | Phoenix Euroblock | Phoenix Euroblock | NL4 | NL4 plus central NL8 | NL4/EP5 plus central NL8 |
| GPIO connector, 5 ports | Phoenix Euroblock | Phoenix Euroblock | No | No | No |
| Cable compensation | LoadMatch | LoadMatch | No | LoadMatch | LoadMatch |
| Power supply | Universal range switched mode power supply with active PFC | Universal range switched mode power supply with active PFC | Autosensing switched mode power supply with active PFC | Universal range switched mode power supply with active PFC | Autosensing switched mode power supply with active PFC |
| Mains voltage | 100 - 240 V, 50 - 60 Hz | 100 - 240 V, 50 - 60 Hz | 100 - 120/220 - 240, 50 - 60 Hz | 100 - 240 V, 50 - 60 Hz | 100 - 127/208 - 240 V, 50 - 60 Hz |
| Weight (kg/lb) | 10.6/23.4 | 10.6/23.4 | 8/17.6 | 10.8/23.8 | 19/42 |
| Dimensions | 2 RU x 19" x 435 mm | 2 RU x 19" x 435 mm | 2 RU x 19" x 353 mm | 2 RU x 19" x 460 mm | 2 RU x 19" x 530 mm |
| Remote | OCA via Ethernet/CAN | OCA via Ethernet/CAN | CAN | OCA via Ethernet/CAN | OCA via Ethernet/CAN |
| Airflow |  |  |  |  |  |

The operation with d&b amplifiers

Amplifier controller setups

CUT mode

Set to CUT, the cabinet low frequency level is reduced and is configured for use with d&b active subwoofers.

HFC mode

Selecting the HFC (High Frequency Compensation) mode compensates for loss of high frequency energy due to absorption in air when loudspeakers are used to cover far field listening positions. The HFC mode has two settings (HF1, HF2) for different distance ranges the cabinets have to cover, HF1 for distances larger than 25 m (80 ft) and HF2 for distances larger than 50 m (160 ft). Using HFC provides the correct sound balance between close and remote audience areas, whilst all amplifiers driving the array can be fed with the same signal.

HFA mode

In HFA mode (High Frequency Attenuation), the HF response of the system is rolled off. The HFA provides a natural, balanced frequency response when a unit is placed close to listeners in near field or delay use. High frequency attenuation begins gradually at 1 kHz, dropping by approximately 3 dB at 10 kHz. This roll-off mimics the decline in frequency response experienced when listening to a system from a distance in a typically reverberant room or auditorium.

CPL function

The CPL (Coupling) function compensates for coupling effects between closely coupled cabinets by reducing the low and mid frequency level. CPL begins gradually around 1 kHz, with the maximum attenuation below 200 Hz. To achieve a balanced frequency response the CPL function can be set to dB attenuation values between 0 and -9. Positive CPL values create an adjustable low frequency boost (0 to +5 dB) and can be set when the system is used in full-range mode without subwoofers.

Arc and Line mode

The Arc mode is selected for line array loudspeakers when used in curved array sections with splay angles between 5° and 15°. The Line mode is used for long throw array sections with three or more consecutive splay settings between 0° and 4°. Compared to the Arc setup, the upper mid range is reduced to compensate for the extended near field.

100 Hz mode

The 100Hz mode limits the upper operating frequency of the subwoofer to 100Hz, complementing top cabinets in full range mode.

Recommended amplifier for installation applications

| | 10A/ 10A-D | 10AL/ 10AL-D | 18A-SUB | 27A-SUB |
|------------|---------------|-----------------|---------|---------|
| 30D | x | x | x | x |

Maximum loudspeakers per amplifier channel

| | 10A/ 10A-D | 10AL/ 10AL-D | 18A-SUB | 27A-SUB |
|--|---------------|-----------------|---------|---------|
| | 3 | 3 | 2 | 2 |

Available controller settings

| | 10A/ 10A-D | 10AL/ 10AL-D | 18A-SUB | 27A-SUB |
|-----------------|---------------|-----------------|---------|---------|
| CUT | x | x | | |
| HFC | | x | | |
| HFA | x | | | |
| CPL | x | x | | |
| Arc/Line | | x | | |
| 100 Hz | | | x | x |

The xA-Series frequency responses

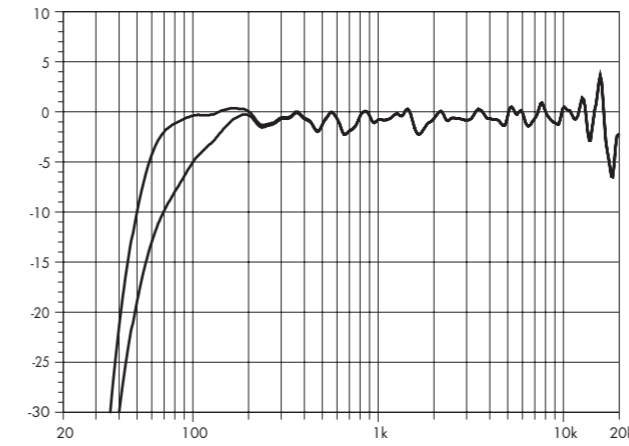

10A standard and CUT

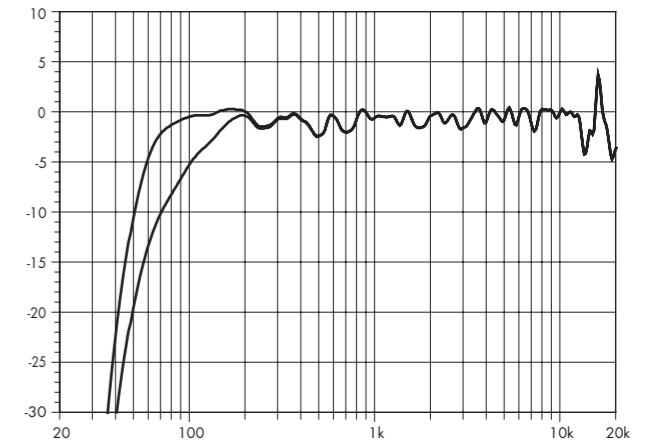

10A-D standard and CUT

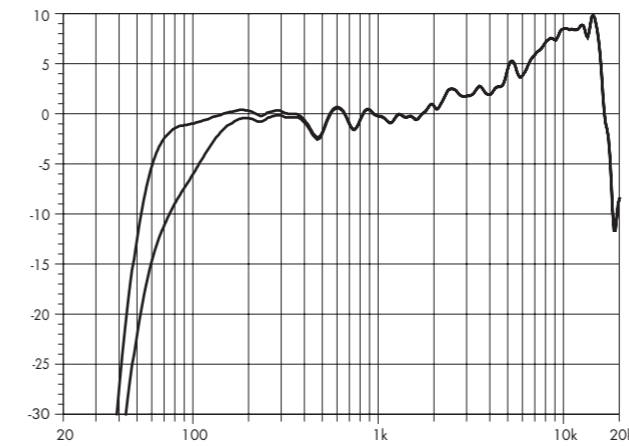

10AL standard and CUT

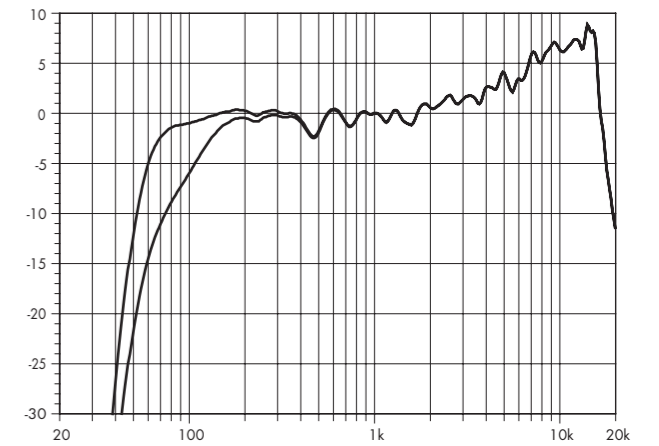

10AL-D standard and CUT

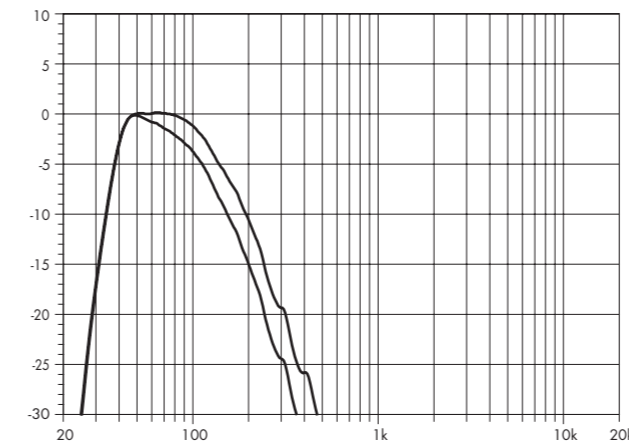

18A-SUB standard and 100 Hz

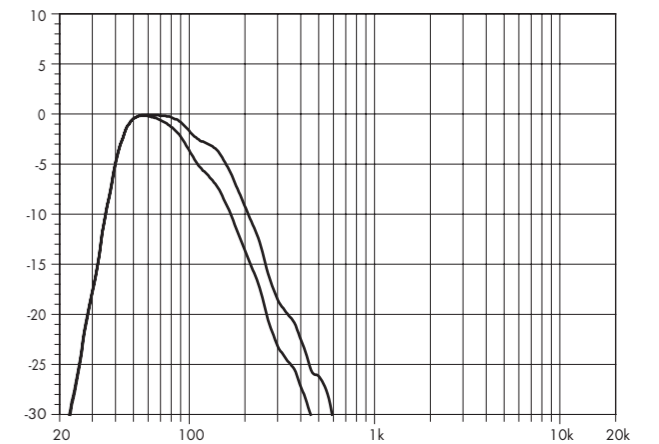

27A-SUB standard and 100 Hz

The d&b amplifier output modes

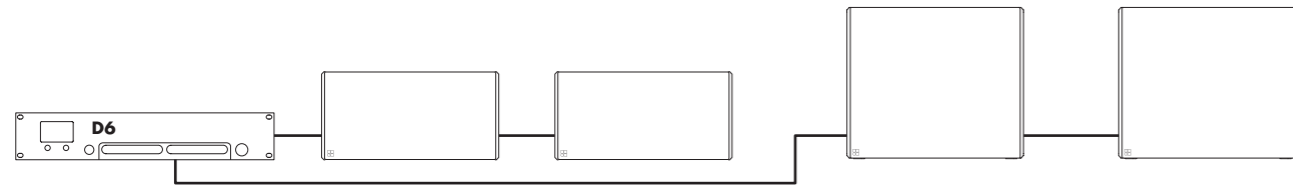

D6 amplifier in Dual Channel mode for 10A, 10A-D, 10AL or 10AL-D and 18A-SUB or 27A-SUB

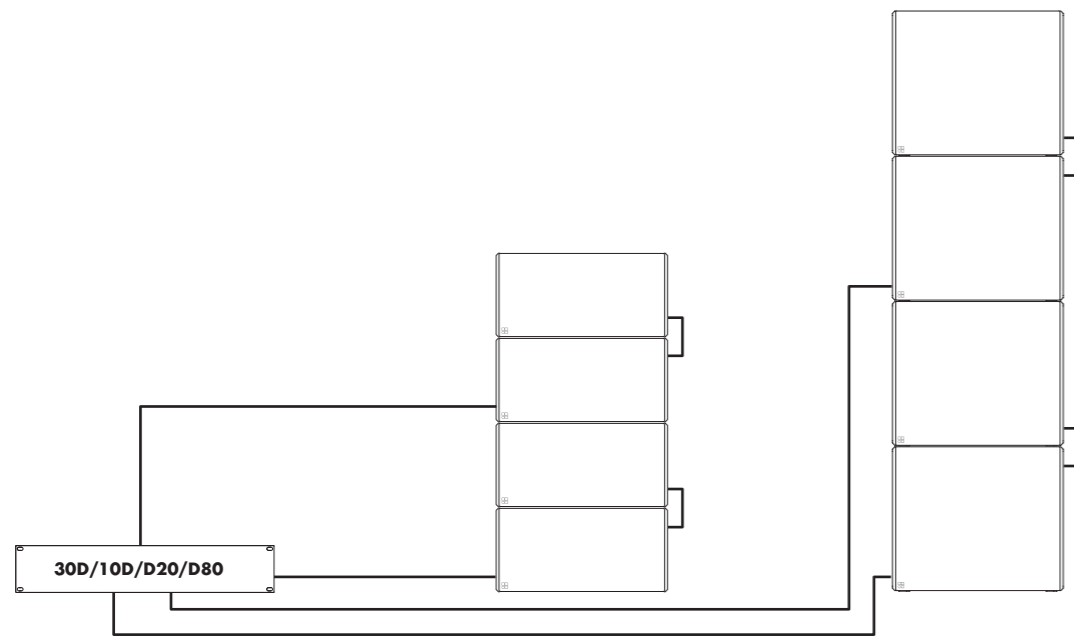

30D/10D/D80/D20 amplifier in Dual Channel mode for 10A, 10A-D, 10AL,10AL-D, 18A-SUB and 27A-SUB

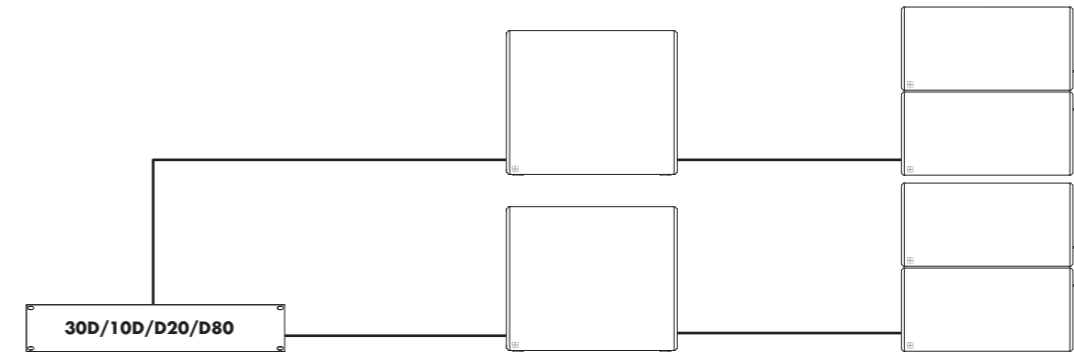

30D/10D/D80/D20 amplifier in Mix TOP/SUB mode for 10A, 10A-D, 10AL,10AL-D, 18A-SUB and 27A-SUB

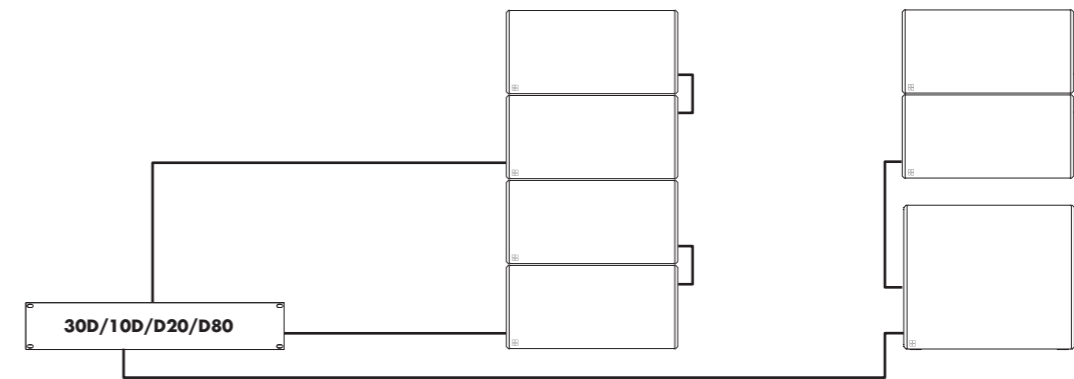

30D/10D/D80/D20 amplifier in a mixed configuration of Dual Channel and Mix TOP/SUB modes for 10A, 10A-D, 10AL, 10AL-D, 18A-SUB and 27A-SUB

The DS10 Audio network bridge

The DS100 Signal Engine

DS10 Audio network bridge

The DS10 Audio network bridge interfaces between Dante networks and AES3 digital audio signals, while also providing distribution of Ethernet control data. Positioned within the signal chain in front of the amplifiers, this 1 RU device expands the d&b system approach. Each unit can deliver up to sixteen Dante network channels via AES3 digital signal outputs. Additionally, four AES3 input channels provide access to the Dante audio network for applications such as a break-in from a Front of House console.

The DS10 incorporates an integrated 5-port switch, offering a primary and redundant network for the Dante protocol, as well as advanced functions such as Multicast Filtering and VLAN modes. Using the DS10 Audio network bridge, audio signals and remote control data can be combined using a single Ethernet cable.



The DS10 Audio network bridge front view



The DS10 Audio network bridge rear view

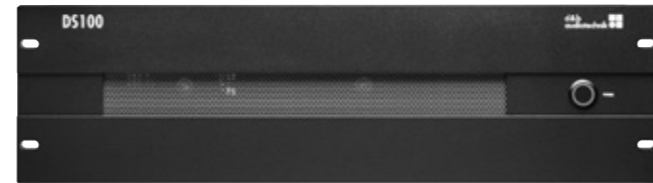

The DS100 Signal Engine front view

DS100 Signal Engine

The d&b DS100 Signal Engine is the platform underneath the Soundscape, based on a specialized rack mount 3 RU audio processor with Audinate Dante networking. It provides a 64 x 64 audio matrix with level and delay adjustments at all cross points. Additional software modules provide dynamic source positioning and emulated acoustics functions.

The DS100 is a versatile tool for use within complex audio systems to route and distribute multiple audio channels to numerous amplifiers driving loudspeaker positions and zones, show relay and break out rooms. The networking capabilities with a Dante enabled processor are significant, particularly for busy, multi-room complexes.

The DS100 completely integrates with the overall d&b system approach, including loudspeakers, amplifiers, rigging, transport and networking accessories and the DS10 Audio network bridge. The complete system is designed and optimized in the d&b ArrayCalc simulation software, and controlled via the d&b R1 Remote control software.

The xA-Series configuration examples

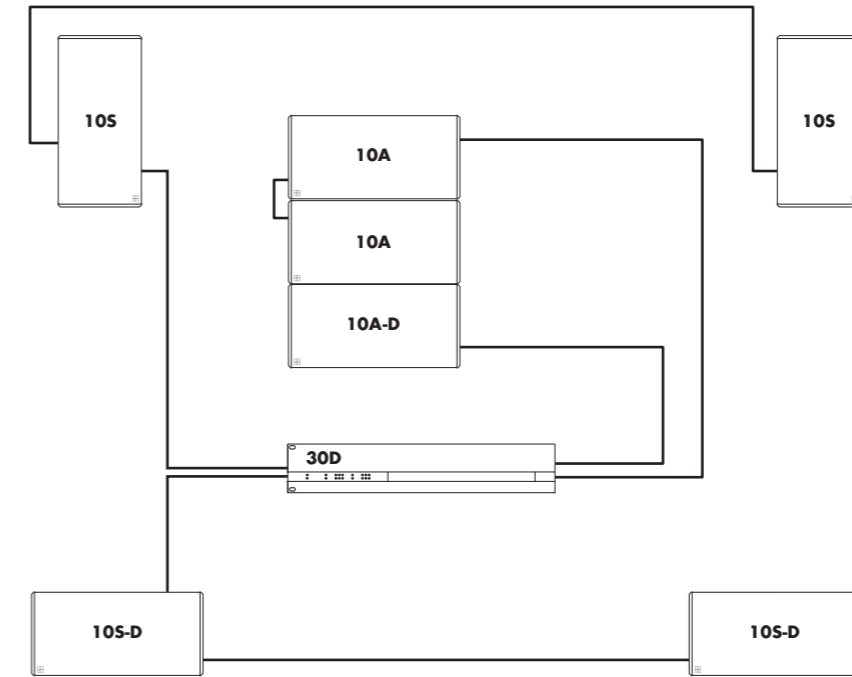

30D amplifier in Dual Channel mode with 10A and 10A-D loudspeakers in vertical array with 10S loudspeakers in L/R configuration and 10S-D loudspeakers as frontfill

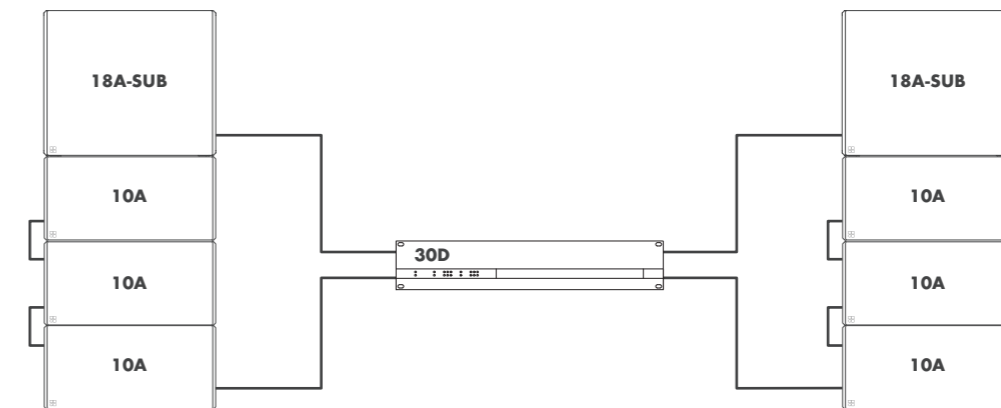

30D amplifier in Dual Channel mode with 10A loudspeakers in vertical array with 18A-SUBs

The xA-Series configuration examples

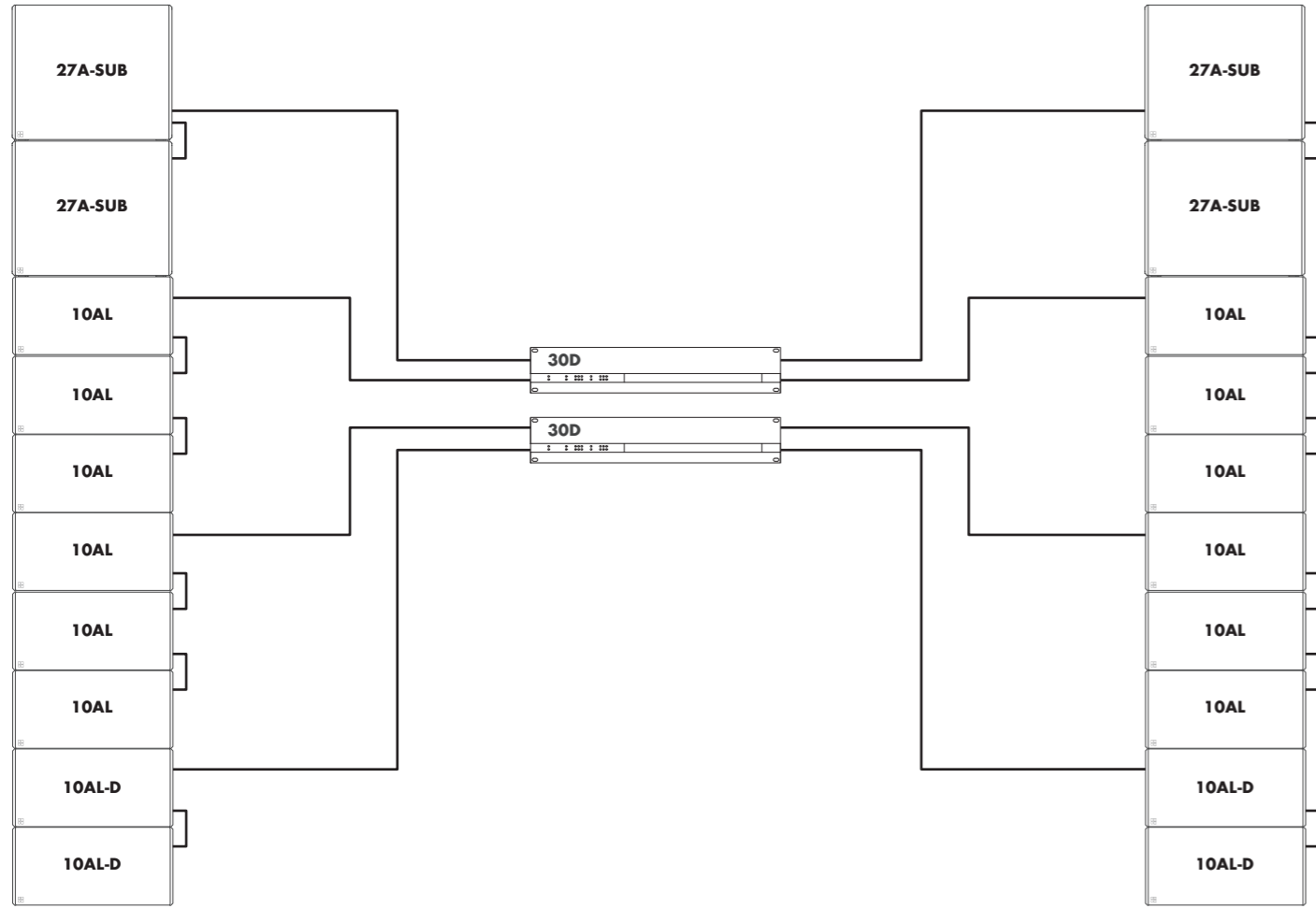

10AL/10AL-D line arrays with flown 27A-SUBs with 30D amplifiers in Dual Channel mode

The xA-Series product overview

| | | |
|------------------------------------|---------------------|--|
| Loudspeakers | Z1620.000 | 10A loudspeaker |
| | Z1621.000 | 10A-D loudspeaker |
| | Z1622.000 | 10AL loudspeaker |
| | Z1623.000 | 10AL-D loudspeaker |
| | Z1627.000 | 18A subwoofer |
| | Z1629.000 | 27A subwoofer |
| Accessories | | WR Weather Resistant¹ |
| | | SC Special Colour² |
| | Z5414.000 | xA Flying bar² |
| | Z5415.000 | xA Flying bar adapter² |
| | Z5413.000 | xA Flying bar connector plate^{2,3} |
| | Z5416.000 | 10A Connector plate^{2,3} |
| | Z5417.000 | 10AL Connector plate^{2,3} |
| | Z5418.000 | xA-SUB Connector plate^{2,3} |
| | Z5421.000 | xA Connector plate negative splay^{2,3} |
| | Z5147.000 | Rota clamp |
| Z5419.000 | Load bar | |
| Z5420.000 | Load eyebolt | |
| Remote network | Z6118.000 | R60 USB to CAN interface |
| | Z6124.000 | R70 Ethernet to CAN interface |
| Amplifiers | Z2770.xxx | 30D amplifier⁴ |
| | Z2760.xxx | 10D amplifier⁴ |
| | Z2700.xxx | D6 amplifier⁵ |
| | Z2750.xxx | D20 amplifier⁵ |
| | Z2710.xxx | D80 amplifier⁵ |
| Processing and distribution | Z4010.000 | DS10 Audio network bridge |
| | Z4100.000 | DS100 Signal Engine |

¹ WR on request

² SC on request

³ Supplied in pairs

⁴ The complete list of installation amplifier versions is available in the xD Installation Amplifier and Software brochure

⁵ The complete list of mobile amplifier versions is available in the D Amplifier and Software brochure

